



ULRIKA PLAZA

Exterior Finish Package



BUILDING 1

BUILDING 2

BUILDING 3

BUILDING 4

COMMON AREA

01 BUILDING 1









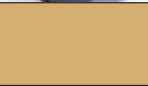

BUILDING 1

BUILDING 2

BUILDING 3

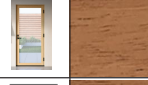
BUILDING 4

COMMON AREA

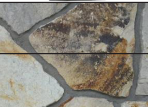
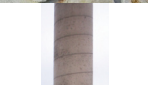
Image	Key	Item	Manufacturer	Type	Color
	RF1-1	Green Roof System	Columbia Green	Tray System	n/a
	CO1-1	Coping	Custom Fabricated	24 Ga. Galvanized Steel	Paint to Match P1-1
	CO1-2	Coping	Custom Fabricated	24 Ga. Galvanized Steel	Paint to Match P1-1
	P1-1	Exterior Paint - Cement Plaster	Benjamin Moore		194 Hathaway Gold
	SV1-1	Stone Veneer	K2	Kettle Valley Country Cottage	Random Field Stone
	CS1-1	Wood Siding	Nakamoto	Pika Pika+Alklyd Oil Natural	NM1705
	W1-1	Windows - Residential	Marvin	Ultimate Casement	Mahogany
	D1-1	Single Panel Doors - Residential	Tru-Style Single Panel	Semi-Gloss	HC-105 Rockport Gray
	D1-2	Single French Doors - Residential	Marvin	Ultimate	Mahogany
	SF1-1	Storefront Windows	Marvin	Ultimate Series	Mahogany
	SF1-2	Storefront Doors	Marvin	Ultimate Series	Mahogany
	PM1-1	Metal Awning	McNichols	Perforated Metal	Corten
	L1-1	Exterior Light Fixture	Access Lighting	Geo 20090LEDMG-BRZ/ACR	Bronze
	RP1-1	Raised Planters	K2	Kettle Valley Country Cottage	Random Field Stone
	CP1-1	Column	Custom Fabricated	Concrete	Natural

RF1-1

- Green Roof System



NEXT GEN GREEN ROOFS AND ROOFTOP PARKS

BUILDING 1

BUILDING 2

BUILDING 3

BUILDING 4

COMMON AREA

LRV: 43.39

Hathaway Gold 194

This color is part of the Classic Color Collection. Surround yourself with y
These timeless, elegant, Classic Colors guarantee beautiful, usable color
A collection of 1,680 inspired hues that consumers and professionals hav
colors in this palette are as timeless as they are forward.

Similar colors / [Cork \(2153-40\)](#)

More shades / [Pearly Gates \(190\)](#)

Go well with / [Blackberry Wine \(2069-20\)](#)

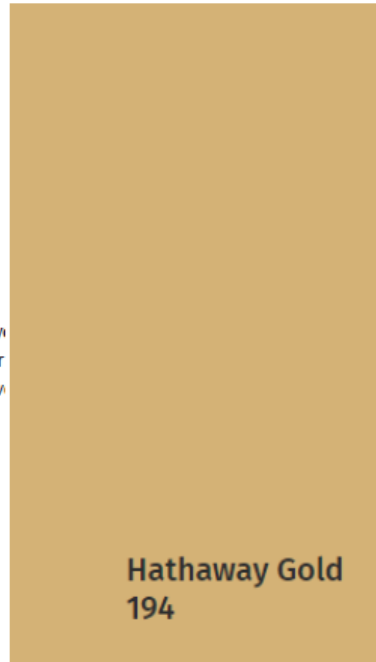

Hathaway Gold
194





KETTLE VALLEY COUNTRY COTTAGE RANDOM / FIELDSTONE



PRODUCT SPECS

STONE THICKNESS:
1/2" - 1-1/2"

STONE SIZE:
5" x 10" up to 8" x 15" pieces.

STONE COLOR:
Tans, browns, greys, creams and beige.

STONE SHAPE:
Random / Irregular

ALL INDIVIDUAL NATURAL STONES

GOOD FOR INTERIOR AND EXTERIOR APPLICATION

AVAILABLE WITH MATCHING 90 DEGREE CUT CORNERS

DESCRIPTION

Channel old world rustic charm with natural stone veneer products such as our popular Kettle Valley Country Cottage Random. As the name suggests, this profile features gently rounded field stone-shaped pieces arranged in a seemingly random pattern. Each irregular shaped stone ranges from a 5" to 10" face height with a 8" to 15" length. The warm and natural colors - tans, browns, greys, creams and beige - reference stone construction in rural Tuscany. Use this product to introduce natural character and beauty both the inside and outside of your home.





Exterior/Interior
Alkyd Oil Natural



Installation Details

Overage

Please add a healthy overage ranging 15~20%, as shipping additional material can be expensive.

Fastening (Exterior)

Two ring or screw-shank headed face nails or screws per furring strip within 1" of each edge

Substrate (Exterior)

Rigid furring maximum 16" on-center

Fastening (Interior)

Tube adhesive and pin nails

Substrate (Interior)

Per design specifications

Installation Layout

Vertical or horizontal, all profiles

Dimensions & Grades Available

Select Grade				
SKU#	Profile	Length	Reveal	SF/pc
PA2312	6" Lap	145 11/16***	5 5/16"	5.33
PB2312	6" S3S	145 11/16"	5 11/16"	5.75
PE2312	8" Lap	145 11/16"	7 5/16"	7.33
PF2312	8" S3S	145 11/16"	7 11/16"	7.75
Premium Clear Grade				
SKU#	Profile	Length	Reveal	SF/pc
PD2312	6" Lap	145 11/16"	5 5/16"	5.33

** 72", 96", 120" lengths sometimes available

Prefinish Specifications

Prefinish Option	1 Coat Alkyd Oil
Prefinish Color	Natural
Exterior Application	Yes
Interior Application	Yes
Back-Oiling Option	Available
2nd Coat Oil Option	Available
Shop-Applied Fire Retardant	Not available
Pressure Treated Fire Retardant	Select grade 1x6x12 shiplap only



**Manufacturer
Nakamoto Forestry North America**

Warehouse and Office (By Appt Only)
6400 SE 101st Ave Unit 2C & 3C
Portland Oregon 97266
Tel. (503) 512-6780

Mailing and Billing
4110 SE Hawthorne Blvd. #190
Portland Oregon 97214

Pika-Pika with Alkyd Oil Prefinish NATURAL (previous SKU# NM1705)

Yakisugi "shou sugi ban" siding and paneling. Wire-brushed, textured surface, with all loose soot removed revealing a striped pattern. Suitable for exterior and interior applications. Delivered ready to install.

Product does not shed soot after installation

Copy and Paste into Appropriate CSI Division

SECTION 06 26 00 or 07 46 00
CHARRED WOOD [SIDING] [&] [PANELING]

Surface & Texture

Pika-Pika is a surface with deep wire-brushed topography of soft early wood valleys and burnt late wood ridges.

Species

Cryptomeria japonica, a monotypic genus in the Cypress family native to Japan. The Japanese name is "Sugi" (as in yakisugi and shou sugi ban), and in the West it is colloquially known as "Japanese Cedar".

Wood Grade

Select - JAS "Small Knot" grade allows for up to 20 tight or 10 dead knots per 79" (2m) board length. Unlimited combination of heartwood and sapwood, pith allowed. Checks allowed to 1/16" as long as plank stability, weather-resistance, and cosmetics are not adversely affected.

Premium Clear - JAS "Joko Mubushi" grade allows for up to 4 tight or 3 dead pinhole knots per 79" (2m) board length. Unlimited combination of heartwood and sapwood, no pith allowed. Checks allowed to 1/16" as long as plank stability, weather-resistance, and cosmetics are not adversely affected.

Fire Resistance

Pika-Pika tests to ASTM E84 and UL723 Class B Flame Spread and Smoke Developed without fire retardant and Class A with fire retardant. Species tests to CAN/ULC S102-10 FS of 25 and SDC of 60 without fire retardant. Pressure treated with fire retardant available in select grade 1x6x12 shiplap only. Acceptable for Calfire WUI zone exterior applications as cladding over a 60-minute Class A wall assembly.

Moisture Content

Air dried then kiln dried to 11~14% MC, but may fluctuate during transport or warehousing. Please acclimate on site for two weeks prior to installation.

1x6 Shiplap Dimensions

- Nominal 1x6x12
- 5 1/4 inches (135mm) actual reveal
- 145 1/4 inches (3700mm) actual length
- 5.33 SF/piece

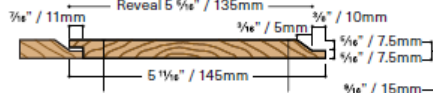

1x6 Square Edge Dimensions

- Nominal 1x6x12
- 5 1/4 inches (145mm) actual reveal
- 145 1/4 inches (3700mm) actual length
- 5.75 SF/piece



1x8 Shiplap Dimensions

- Nominal 1x8x12
- 7 1/4 inches (185mm) actual reveal
- 145 1/4 inches (3700mm) actual length
- 7.33 SF/piece

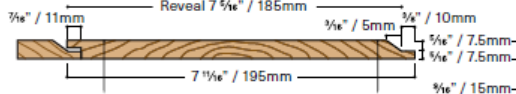

1x8 Square Edge Dimensions

- Nominal 1x8x12
- 7 1/4 inches (195mm) actual reveal
- 145 1/4 inches (3700mm) actual length
- 7.75 SF/piece

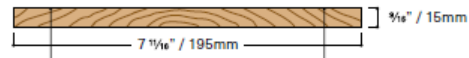

*Dimensional shrinkage after manufacture is possible due to being a solid-sawn wood product.



W1-1, SF1-1

Windows - Residential,
Storefront Windows

ULTIMATE CASEMENT STYLES



Casement and Picture windows with Satin Nickel hardware

28 MARVIN SIGNATURE® COLLECTION

BUILDING 1

BUILDING 2

BUILDING 3

BUILDING 4

COMMON AREA

MARVIN®

FULL FRAME OR NARROW FRAME

The Ultimate Casement and Ultimate Casement Narrow Frame windows are the most versatile and innovative casement windows ever produced. Ultimate Casement styles feature concealed multi-point locks, a patented Wash Mode, and durable hardware that operates smoothly even at the largest sizes.

WOOD

Wood is a premium material for windows and doors, offering classic aesthetic appeal, many options for customization, and design versatility.

We treat exposed millwork with a water repellent wood preservative to help it last longer. Choose from one of the four options below. Each is ready to be finished to match your project's exacting requirements.

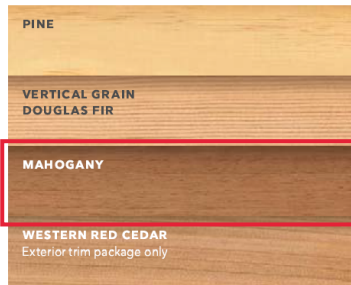

ULTIMATE CASEMENT

A recessed sash for a traditional look, plus a full jamb, offers design flexibility for new construction or full frame replacement.



ULTIMATE CASEMENT NARROW FRAME

A flush sash to the exterior and narrow jamb depth make this window an easy choice for frame-in-frame replacement or more contemporary new construction applications.



ULTIMATE CASEMENT EXTERIOR WITH 4 3/4" FULL JAMB

JAMBS + PROFILES

The Ultimate Casement has a recessed sash for a traditional or historic look. The Ultimate Casement Narrow Frame has a flush-to-frame sash for a contemporary look.



ULTIMATE CASEMENT NARROW FRAME EXTERIOR WITH 2 3/4" NARROW JAMB

ULTIMATE SWINGING NARROW PROFILE DOOR



Inswing door in Hazelnut with unequal panel widths and Matte Black hardware

MARVIN®



Inswing Door in Pine with Matte Black hardware

ULTIMATE SWINGING NARROW PROFILE DOOR

The Ultimate Swinging Narrow Profile Door, available in both Inswing and Outswing, is expertly crafted to provide industry-leading performance with narrow sightlines and robust 2 ¼ inch standard panel thickness. Featuring contemporary 3 inch stiles and rails along with square interior and exterior profiles. Choose from one or two operating panels in configurations up to 4 panels. Sizes up to 10 feet high and 14 feet wide.

WOOD

Wood is a premium material for windows and doors, offering classic aesthetic appeal, many options for customization, and design versatility. We treat exposed millwork with a water repellent wood preservative to help it last longer. Choose from one of the four options below. Each is ready to be finished to match your project's exacting requirements.

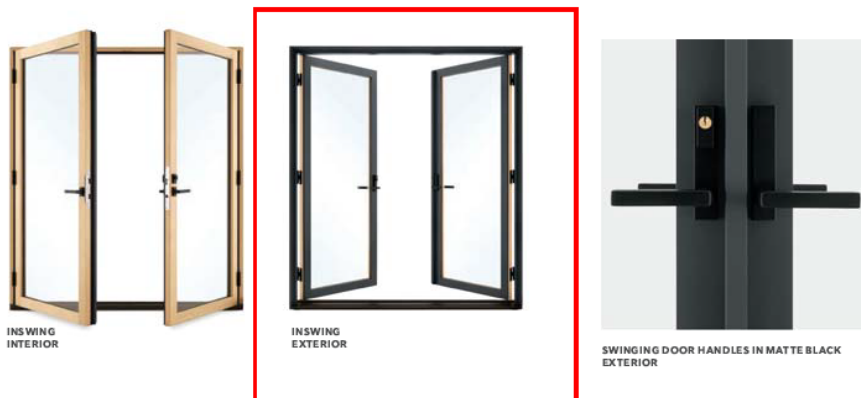
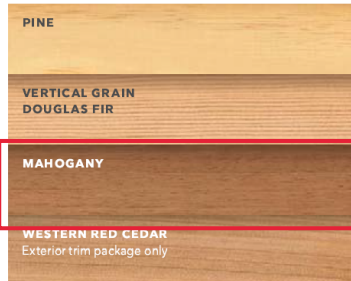

TRUSTILE
A MARVIN BRAND

WOOD DOOR CONSTRUCTION

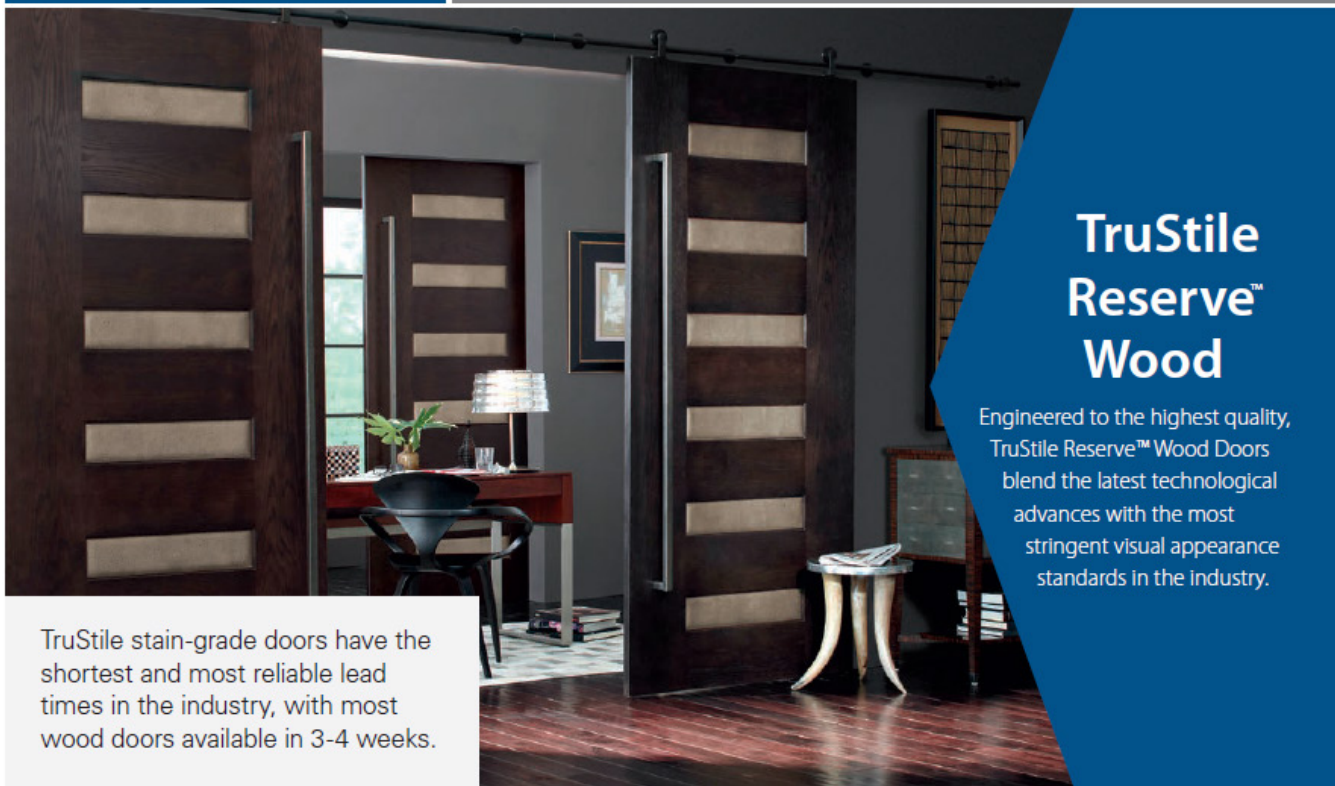

TruStile Reserve™ Wood

Engineered to the highest quality, TruStile Reserve™ Wood Doors blend the latest technological advances with the most stringent visual appearance standards in the industry.

TruStile stain-grade doors have the shortest and most reliable lead times in the industry, with most wood doors available in 3-4 weeks.

TruStile Wood

Made in the authentic stile and rail manner, TruStile Wood Doors use a premium mix of materials that exceed industry standards for a truly natural look.



www.trustile.com



TS1000

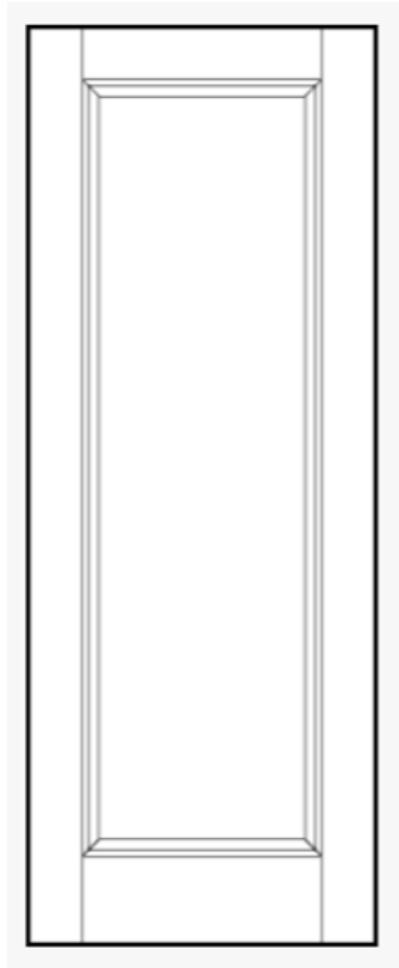

**Benjamin Moore
Rockport Gray: HC-105**

TRUSTILE
A MARVIN BRAND

WOOD DOOR CONSTRUCTION



TruStile Reserve™ Wood

Previously TruStile Wood

- The TruStile Reserve series incorporates only the finest materials and methods. We have developed a proprietary specification based on the AWI (Architectural Woodwork Institute) standard for AA Premium Grade doors.
- Engineered panel made with a composite core for strength and stability while maintaining the look of a solid wood panel construction.
- Precision-cut cope and stick joinery for a meticulous, uncompromising look.
- The strength and durability of engineered stiles is employed for the ultimate in stiffness to resist bowing, twisting or warping.



TruColor Hand-Matched Veneers

TruStile created a proprietary color matching and grading system to ensure only the best veneers and lumber are used to handcraft your door. Based on the AWI AA Premium Grade standard, but taken a step further, TruStile Reserve Doors are unmatched in beauty.



TruStile Wood

Previously Woodharbor

- Parts are tested and sorted into a premium mix of components that exceed industry standards. All components are blended for color and grain pattern matching.
- Edge-glued solid wood panels for a premium look and feel.
- Traditional dowel construction creates a solid joint.
- An engineered stave lumber core is cut to size with alternating grain patterns, which balances the core and reduces wood's natural tendency to move.

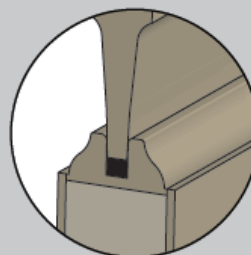

Floating Panel System

TruStile wood doors are engineered with a unique floating panel system that allow expansion and contraction while securing the panel to prevent shifting, settling and rattling. Flexible cushions are inserted between the sticking and panels. This allows the wood to expand and contract while holding the panel in position.

Rockport Gray

HC-105



A rich medium gray with the barest trace of violet undertone.

[Add to Cart](#)



[Find a Store](#)

[Benjamin Moore](#) [Paint Colors](#) [Products](#) [Paint Ideas](#) [For Professionals](#)

DOOR FEATURES + OPTIONS



BEAUTY WITH PERFORMANCE

Designed for durability and to minimize air and water infiltration. Many of our door products are certified to a light commercial rating of PG40.

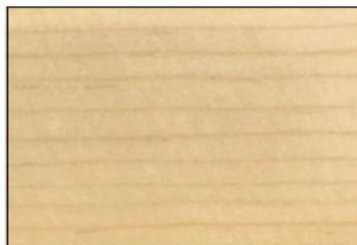

SOLID WOOD PANELS + FRAMES

The sound of a Marvin door closing is a quiet statement of quality. Wood in the panels and frames make for an elegant, crafted look and feel, and provide a weather-tight closure for outstanding energy efficiency.*

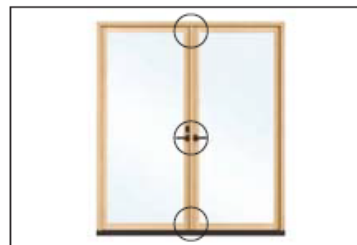

MULTI-POINT LOCKING SYSTEM

Concealed stainless steel head and foot bolts within the door secure it solidly at three points. Choose either a keyed or non-keyed lever handle. Multi-point lock comes standard.

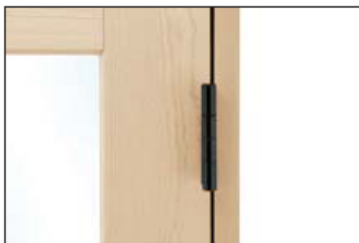

ADJUSTABLE HINGE

Standard on swinging doors, an adjustable hinge makes it easy to fine-tune the fit of a swinging door over the door's lifetime. Available in a variety of finishes, plus coastal options.

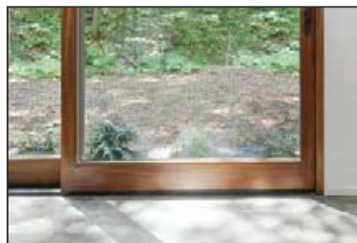

LOW PROFILE SILL

This innovative sill option on select door types provides for a smooth transition between exterior and interior living spaces.



RAISED AND FLAT PANELS

Raised and flat panels add depth and style to sliding and swinging French doors, including arch top swinging doors. This option changes the overall aesthetic of your door when less than a full lite of glass is desired.

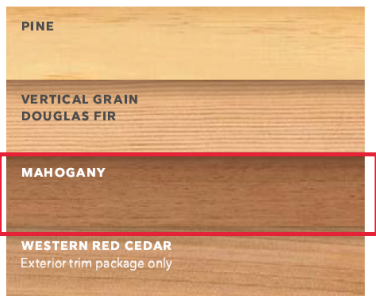

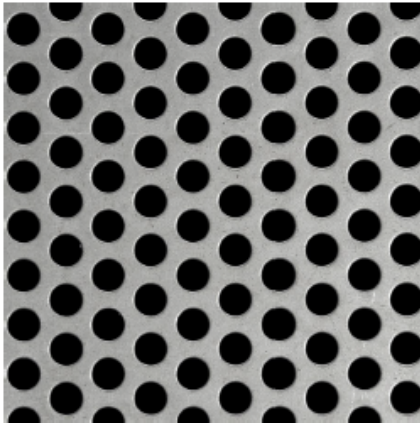

McNICHOLS[®] Perforated Metal

Round, Carbon Steel, Cold Rolled, 16 Gauge (.0598" Thick), 3/8" Round on 9/16" Staggered Centers, 40% Open Area, 48" x 120"

McNICHOLS[®] Perforated Metal, Round, Carbon Steel, Cold Rolled, Mill Finish, 16 Gauge (.0598" Thick), 3/8" Round on 9/16" Staggered Centers, 3/16" Bar Width, 3.62 Holes Per Square Inch (HPSI), Minimum Solid Margins Both Sides of Sheet Parallel to Length of Sheet, Holes Sheared Through Both Ends of Sheet Parallel to Width of Sheet, 40% Open Area

ITEM 1638911641 - 48" x 120"

ITEM SPECIFICATIONS

Item Number	1638911641
Product Line	Perforated Metal
Hole Type	Round
Primary Material	Carbon Steel (CS)
Alloy, Grade or Type	Cold Rolled (CR)
Material Finish	Mill Finish
Gauge/Thickness	16 Gauge (.0598" Thick)
Hole Pattern	3/8" Round on 9/16" Staggered Centers
Hole Size (Diameter)	3/8"
Hole Centers	9/16"
Bar Width	3/16"
Hole Arrangement	60° Staggered Centers
Holes Per Square Inch (HPSI)	3.62
Straight Rows Parallel to	Length of Sheet
Margins Parallel to Width	Sheared Through Both Ends
Margins Parallel to Length	Minimum Solid Both Sides
End Pattern	Sheared Through Both Ends
Percent Open Area	40%
Weight	1.50 Lbs./Square Foot
Product Form	Sheet
Sizes (Width x Length)	48" x 120" (Cut Sizes Available)

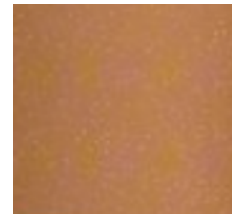

**KRYLON
Copper Metallic:
Spray On**

Stock Code: **20090LEDMG-BRZ/ACR**

Collection: GEO

PRODUCT INFORMATION

Base: 20090 Parent: 20090LEDMG
 Mounting Type: Wall UPC: 641594244441
 Finish: Bronze
 Diffuser: Acrylic Lens

PRODUCT MEASUREMENTS

FIXTURE	BACKPLATE / CANOPY
Length:	Length:
Width: 6.5"	Width:
Diameter:	Diameter:
Height: 12"	Height:
Extension: 4"	
Overall Height:	

TECHNICAL SPECIFICATIONS

SPECIFICATIONS

Frame Material: Steel
 Diffuser Material: Acrylic
 Lamping Type: SSL (Dedicated LED) Jbox: Standard
 Lamping Base: SSL Lamp Wattage: 15 W
 Lamp Quantity: 1 Total Wattage: 15 W
 Voltage: 120-277v Lamps Included: Yes

QUALIFICATIONS

Location Rating: Wet
 Certification: ETL (US/Canada) Listed
 ADA Compliant: Yes Energy Star: No
 JA8 Compliant: Outdoor Only Emergency Lighting: No
 Marine Grade Finish: Yes
 Warranty: 5 Year

PHOTOMETRICS

Dimmable: Yes Nominal Lumens: 1400 Lm
 CRI: 90 Delivered Lumens: 1040 Lm
 CCT: 3000K
 Recommended Dimmers:
 (TRIAC)LUTRON Diva DVCL-153P; (ELV)LUTRON Maestro CL
 MACL-153M

ADDITIONAL NOTES

Optional Color Temperature 100 Piece Minimum Order Quantity;
 Custom Finish 100 Piece Minimum Order Quantity

Project Name: _____
 Location: Ulrika Plaza Building 1
 Type: _____
 Quantity: _____
 Notes: _____



LINE DRAWING

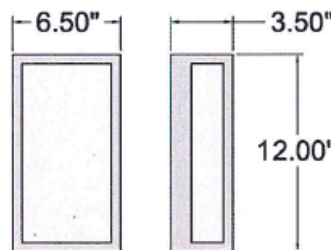

IES FILE

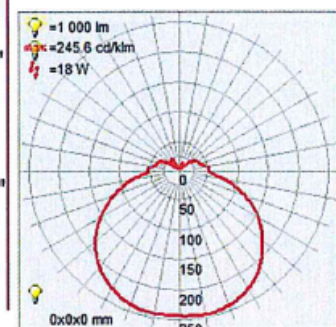

In addition to Access Lighting's purchase and warranty terms and conditions, by signing below or placing an order, you agree that you are authorized to bind the entity placing any order and acknowledge the following: All of sizes and measurements are approximate and all images are for illustrative purposes only. In the event of an inconsistency, the "Product Measurements" section controls. There also may be slight differences in the colors and designs compared to the displayed and printed images.

Signature: _____

Print Name _____ Date: _____

Toll Free 800-828-5483 www.AccessLighting.com

14410 Myford Road, Irvine, CA 92606

The information is subject to change without notice. 12/22/2022 20090LEDMG-BRZ_ACR.pdf



02 BUILDING 2











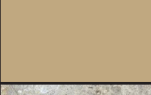
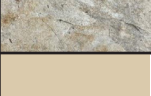
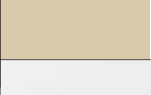
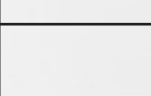

BUILDING 1

BUILDING 2

BUILDING 3

BUILDING 4

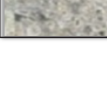
COMMON AREA

Image	Key	Item	Manufacturer	Type	Color
	RF2-1	Cedar Shingle Roof	Watkins Sawmills Ltd.	No. 2 Grade, Red Label	Western Red Cedar Natural
	G2-1	Gutter	Custom Fabricated	5" Galvanized Ogee	Paint to Match CW2-1
	DS2-1	Downspouts	Custom Fabricated	3" Diameter 24 Ga. Galvanized Steel	Paint to Match Body CS2-1
	P2-1	Exterior Paint - Cement Plaster	Benjamin Moore		Brunswick Beige 1061
	SV2-1	Stone Veneer	Graniterock	Cooper Maria	Natural
	CS2-1	Exterior Paint - Cedar Shingle Siding (Ribbon Style)	Benjamin Moore		Putnam Ivory HC-39
	CW2-1	Window Trim	Benjamin Moore		White Dove OC-17
	CT2-1	Wood Balcony Pickets	Benjamin Moore		White Dove OC-17
	W2-1	Windows - Residential	Marvin	Ultimate Series Double Hung	Sierra White
	D2-1	Doors - Residential	Tru-Style Single Panel	Semi-Gloss	Paint to Match W2-1
	D2-2	Sliding Patio Doors - Residential	Marvin	Ultimate	Paint to Match W2-1
	D2-3	Single French Doors - Residential	Marvin	Ultimate	Paint to Match W2-1
	SF2-1	Storefront Windows	Marvin	Ultimate Series	Mahogany
	SF2-2	Storefront Doors	Marvin	Ultimate Series	Mahogany
	L2-1	Exterior Light Fixture	Evergreen Lighting	Series 10 102115LS 15 LED	Architectural Bronze
	RP2-1	Raised Planters	Graniterock	Cooper Maria	Natural
	TR2-1	Trellis	Custom Fabricated	Redwood or Cedar	Paint to Match CT2-1
	ST2-1	Limestone Tile	Halquist	Lisbon Bianco	Brushed



BEAUTY & QUALITY...
NATURALLY BY



RED CEDAR Shingles



This type of smooth sawn architecturally uniform cedar shingle is preferred for its natural and tailored appearance and is used on traditional and modern residential and non-residential structures. For use on roofs and sidewalls.



Watkins
Sawmills
Ltd.

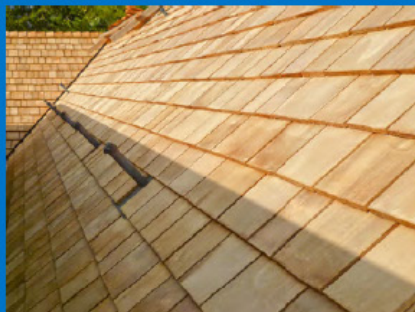

Beautiful • Durable • Insulative • Wind Resistant
Withstands Thermal Shock • Impact Resistant • Light Weight

Red Cedar Shingles

NUMBER 1 GRADE, BLUE LABEL®

Description: Lengths 16-inch (Fivex), 18-inch (Perfection), 24-inch (Royal); width 4" minimum, 14" maximum on 24-inch and 3" on 16-inch and 18-inch; thickness of 16-inch is 5/2" (5 butts together measures 2" thick), 18-inch is 5/2 1/4" thick, 24-inch is 4/2" thick. Clear heartwood; 100% edge grain; no defects.

Recommended Use: For walls and roofs on 3:12 pitch and steeper where a premium quality product is desired.

NUMBER 2 GRADE, RED LABEL

Description: Lengths 16-inch, 18-inch, 24-inch; thickness of 16-inch is 5/2", 18-inch is 5/2 1/4", 24-inch is 4/2"; width 4" minimum, 14" maximum. Face must be 10", 11" and 16" clear or better on 16-inch, 18-inch and 24-inch shingles, respectively. Limited sapwood and flat grain are allowed. Limited knots and defects are allowed above the clear portion.

Recommended Use: For walls and roofs on 3:12 pitch and steeper where a good quality product is desired.

NUMBER 3 GRADE, BLACK LABEL

Description: Lengths 16-inch, 18-inch, 24-inch; thickness of 16-inch is 5/2", 18-inch is 5/2 1/4", 24-inch is 4/2"; width 3" minimum, 14" maximum on 18-inch and 24-inch, 2 1/2" minimum on 16-inch. Face must be 6" clear on 16-inch and 18-inch, 10" clear on 24-inch. Unlimited sapwood and flat grain are allowed. Limited knots and defects are allowed above the clear portion.

Recommended Use: For walls and roofs on 3:12 pitch and steeper where an economy product is acceptable.

UNDERCOARSING GRADE

Description: Lengths 16-inch, 18-inch, thickness 5/2" and 5/2 1/4", respectively; width 2 1/2" minimum, 17" maximum. Unlimited defects; flat grain and sapwood.

Recommended Use: A utility grade for undercoarsing of double coursed sidewalls only. Not a roofing material and not to be used as a starter course for roofs.

SPECIAL UNDERCOARSING

Same grade requirements as undercoarsing grade, except each bundle also contains the machine production of No. 3 grade shingles.

Roof Exposure Table

PITCH	Minimum exposure recommended for roofs		
	Length		
	No. 1 Blue Label	No. 2 Red Label	No. 3 Black Label
	16" 18" 24"	16" 18" 24"	16" 18" 24"
3/12 to 5/12	3 3/4" 4 1/4" 5 3/4"	3 1/2" 4" 5 1/2"	3" 3 3/8" 5"
4/12 and steeper	5" 5 1/2" 7 1/2"	4" 4 1/2" 6 1/2"	3 1/2" 4" 5 1/2"

Wall Exposure Table (Number One Grade)

Shingle Length	Max. Weather Exposure	
	Single Course	Double Course
16"	7"	12"##
18"	8"	14"##
24"	10 1/2"	16"

Maximum exposure for #2 grade is 9".
Maximum exposure for #2 grade is 10".

- Class B & C fire rating may be obtained by specifying FSR permanent fire retardant shingles.
- CCA treated shingles are available for added longevity. Contact the treatment company for treatment warranty information, accessory product requirements (including recommended fastener types) and application details for treated cedar material.
- Products are manufactured and graded in accordance with UBC Standards No. 15-4 and/or CSA 0118.1.
- This is only a product description necessary for selection of materials and grades. For a new roof construction manual and/or wall manual please contact:

Watkins Sawmills Ltd.

PO Box 314, Sumas, WA USA 98295
Telephone: (604) 462-7116 • Fax: (604) 462-7162
Email: Sales@watkinsawmills.com
Toll Free: 1-800-663-8301



PO Box 3280, Mission, British Columbia V2V 4J4
Telephone: (604) 462-7116 • Fax: (604) 462-7162
Email: Sales@watkinsawmills.com
Toll Free: 1-800-663-8301



24 Gauge Galvalume K-Style Gutter

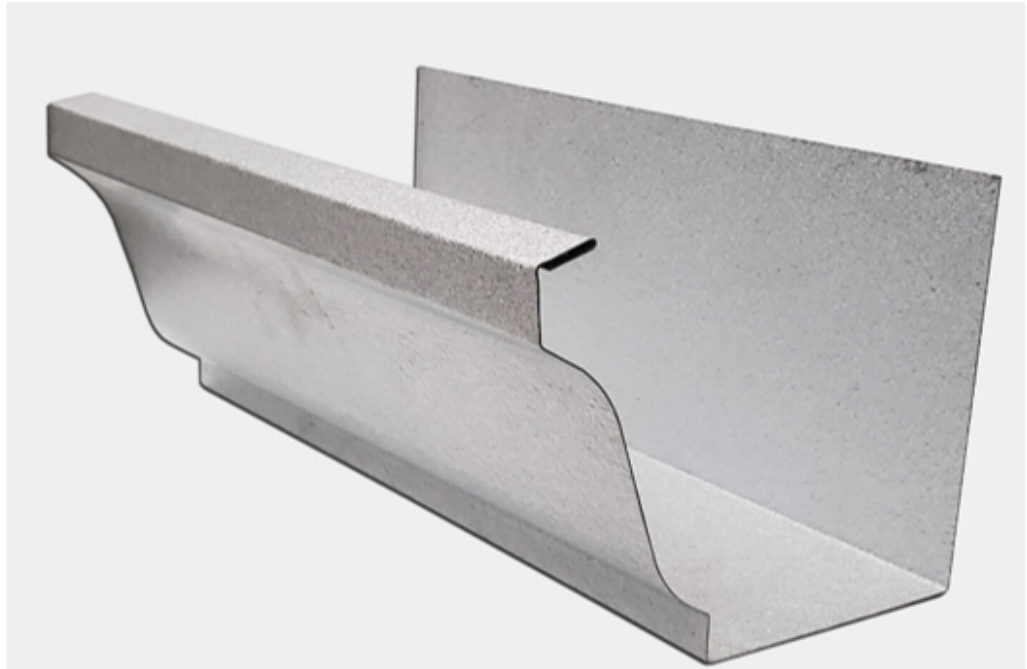

Specifications

- Size **5"** 6", 7" and 8"
- Lengths: 10' and 20'
- Material Thickness: 24 Gauge Galvalume Plus

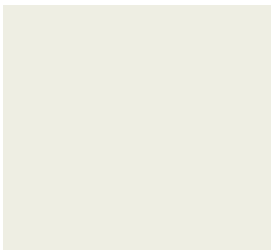

Benjamin Moore
White Dove: OC-17



Galvalume Plus

P2-1

- Exterior Paint - Cement Plaster

BUILDING 1

BUILDING 2

BUILDING 3

BUILDING 4

COMMON AREA



Benjamin Moore

Brunswick Beige: 1061

1061

✔ Sample Ships Overnight

Light Reflectance Value: 39.020

Description: Timeless and traditional, this classic beige relies on a warm yellow undertone to achieve its luminous versatility. This shade works equally well in more modern spaces.

Collection Name: BM Classics



NATURAL STONE



Cooper Maria

Cooper Maria is a beautiful thin veneer stone. This stone is cream with beige and copper earth tones. Its calm colors accent a wide variety of color and stone types. Cooper Maria is packaged on pallets and sold by the ton.





BEAUTY & QUALITY...
NATURALLY BY



**REBUTTED/REJOINTED
Shingles**

**MACHINE GROOVED
Shakes**



These products are manufactured specifically for exterior and interior wall surface uses. They are a low maintenance product that adds beauty, texture, durability and insulating qualities to either new construction or remodelling and renovation of existing structures

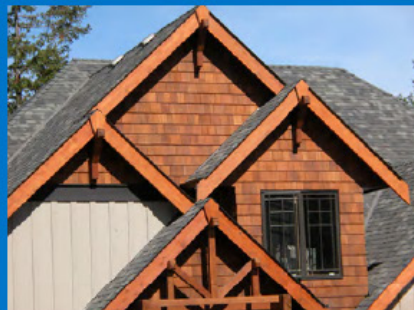

Beautiful • Durable • Insulative • Wind Resistant
Withstands Thermal Shock • Impact Resistant • Light Weight



MACHINE GROOVED Shingles

Appearance: Machine grooved for a shake texture from Number 1 Grade Blue Label CERTIGRADE red cedar shingles, trimmed for parallel edges with butts sawn at right angles.
Finishes: Natural, primed white, primed gray, or special order colors.
Lengths: 16-inch, 18-inch and 24-inch.

NUMBER 1 GRADE, BLUE LABEL

Description: Lengths 16-inch, 18-inch, 24-inch; width 14" maximum, 4" minimum; thickness of 16-inch is 5/2" (5 butts together measures 2" thick), 18-inch is 5/2-1/4" thick, 24-inch is 4/2" thick.
 Clear heartwood: 100% edge grain; no defects.

Recommended Use: For exterior or interior walls where a superior quality product is desired.

Wall Exposure Table:

Shingle Length	Max. Weather Exposure	
	Single Course	Double Course
16"	7"	12"
18"	8"	14"
24"	10½"	16"

REBUTTED/REJOINTED Shingles

Appearance: Manufactured from Number 1 Grade Blue label or Number 2 Grade Red label CERTIGRADE red cedar shingles, trimmed for parallel edges with butts sawn at right angles. Available in both sawn and sanded face textures.
Finishes: Natural, primed white, primed gray, or special order colors.
Lengths: 16-inch, 18-inch and 24-inch.

NUMBER 1 GRADE, BLUE LABEL

Description: Lengths 16-inch, 18-inch, 24-inch; width 14" maximum, 4" minimum; thickness of 16-inch is 5/2" (5 butts together measures 2" thick), 18-inch is 5/2-1/4" thick, 24-inch is 4/2" thick. Clear heartwood: 100% edge grain; no defects.

Recommended Use: For exterior or interior walls where a superior quality product is desired.

NUMBER 2 GRADE, RED LABEL

Description: Lengths 16-inch, 18-inch, 24-inch; thickness of 16-inch is 5/2" (5 butts together measures 2" thick), 18-inch is 5/2-1/4" thick, 24-inch is 4/2" thick. Width 14" maximum, 4" minimum; Face must be 10", 11" and 16" or better on 16-inch, 18-inch and 24-inch shingles, respectively. Limited sapwood and flat grain are allowed. Limited knots and defects are allowed above the clear portion.

Recommended Use: For exterior or interior walls where a good quality product is desired.

**Wall Exposure Table-
No. 1 Grade, Blue Label*:**

Shingle Length	Max. Weather Exposure	
	Single Course	Double Course
16"	7"	12"
18"	8"	14"
24"	10½"	16"

*Maximum weather exposure for No. 2 Grade, Red Label Rebutted and Rejointed shingles should be in accordance with the manufacturer's recommendations.

- These red cedar shakes and shingles are manufactured in accordance with standards established by the Cedar Shake and Shingle Bureau.
- This is only a product description necessary for selection of materials and grades. For a new roof construction manual and/or wall manual please contact:

PO Box 314, Sumas, WA USA 98295
 Telephone: (604) 462-7116 • Fax: (604) 462-7162
 Email: Sales@watkinsawmills.com
 Toll Free: 1-800-663-8301



PO Box 3280, Mission, British Columbia V2V 4J4
 Telephone: (604) 462-7116 • Fax: (604) 462-7162
 Email: Sales@watkinsawmills.com
 Toll Free: 1-800-663-8301



Benjamin Moore

Putnam Ivory: HC-39

HC-39

✔ Sample Ships Overnight

Light Reflectance Value: 59.270

Description: This color is part of the Historic Color collection. A collection of 191 time-honored hues comprises our most popular palette. Steeped in tradition, the refined, elegant colors of the Historical Collection deliver timeless color that can be used in traditional as well as contemporary spaces. Unveiled in 1976 to celebrate the US bicentennial, a collection of 191 colors inspired by America's historic landmarks.

Collection Name: Historical

Approximate Sample Size: 8 in x 9.25 in

- ✔ Residential Use
- ✔ Commercial Use

CW2-1, CT2-1

Window Trim,
Wood Balcony Pickets

BUILDING 1

BUILDING 2

BUILDING 3

BUILDING 4

COMMON AREA

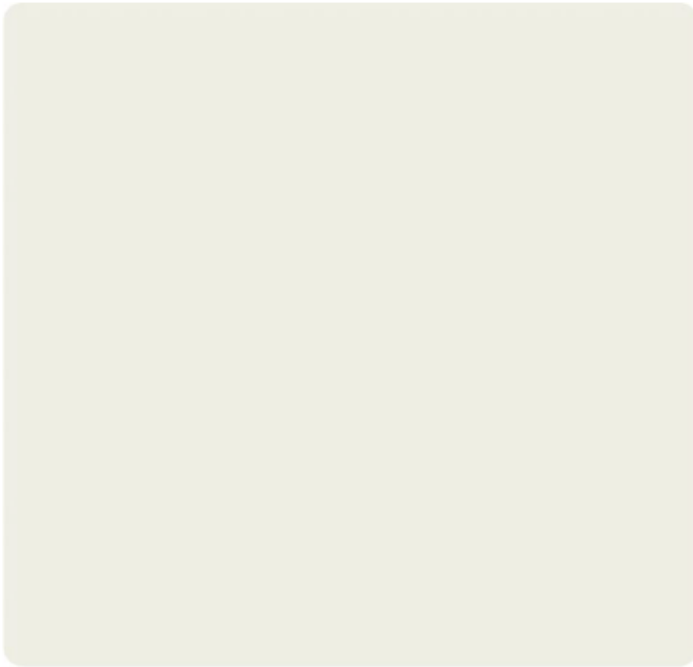

Benjamin Moore

White Dove: OC-17

OC-17

● Ships in 1-5 days from Brand

Light Reflectance Value: 85.380

Description: Unerring style defines this classic, softly shaded white. Light and luminous, it is a favorite choice for moldings and trim.

Collection Name: Off White

Approximate Sample Size: 8 in x 9.25 in

- ✓ **Residential Use**
- ✓ **Commercial Use**

EXTRUDED ALUMINUM

Extruded aluminum is an extremely tough cladding that protects wood windows, mimics the profiles of wood, and provides superior durability. It is the most commonly ordered exterior material for our Ultimate products.

Select a color from our palette of 19 durable extruded aluminum colors, including a spectrum of rich hues and three pearlescent finishes. If you have more specialized needs, we can also work with you to create a custom color.

MARVIN®



Double Hung G2 window in Ebony



Double Hung G2 window in Suede

EXTERIOR FINISH OPTIONS

STONE WHITE

COCONUT CREAM

SIERRA WHITE

CASHMERE

PEBBLE GRAY

HAMPTON SAGE

CADET GRAY

CLAY

WOOD EXTERIOR DOUBLE HUNG WINDOWS



Wood Exterior Double Hung windows with White hardware

MARVIN®



Wood Exterior Double Hung windows with custom stain

WOOD EXTERIOR DOUBLE HUNG WINDOWS

The Ultimate Wood Double/Single Hung, Ultimate Wood Double Hung Magnum, and Ultimate Wood Double Hung Insert are quintessentially American windows designed to fit seamlessly into the historic fabric of your home, neighborhood, or community. With residential and commercial applications, these windows are perfect for any historic building.



WOOD DOUBLE/SINGLE HUNG EXTERIOR



WOOD DOUBLE HUNG MAGNUM INTERIOR



DOUBLE HUNG INSERT EXTERIOR

TRUSTILE
A MARVIN BRAND

WOOD DOOR CONSTRUCTION



TruStile Reserve™ Wood

Engineered to the highest quality, TruStile Reserve™ Wood Doors blend the latest technological advances with the most stringent visual appearance standards in the industry.

TruStile stain-grade doors have the shortest and most reliable lead times in the industry, with most wood doors available in 3-4 weeks.



TruStile Wood

Made in the authentic stile and rail manner, TruStile Wood Doors use a premium mix of materials that exceed industry standards for a truly natural look.

www.trustile.com



TS1000

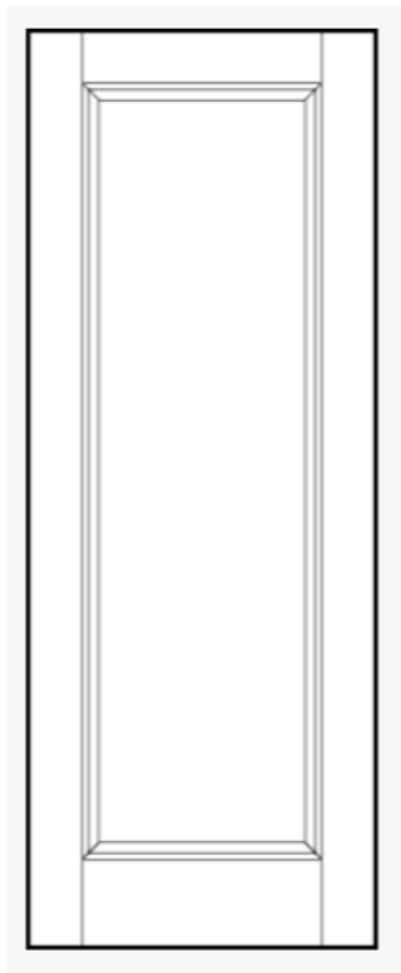

EXTERIOR FINISH OPTIONS	
STONE WHITE	[Color swatch]
COCONUT CREAM	[Color swatch]
SIERRA WHITE	[Color swatch]
CASHMERE	[Color swatch]
PEBBLE GRAY	[Color swatch]
HAMPTON SAGE	[Color swatch]
CADET GRAY	[Color swatch]
CLAY	[Color swatch]



WOOD DOOR CONSTRUCTION



TruStile Reserve™ Wood

Previously TruStile Wood

- The TruStile Reserve series incorporates only the finest materials and methods. We have developed a proprietary specification based on the AWI (Architectural Woodwork Institute) standard for AA Premium Grade doors.
- Engineered panel made with a composite core for strength and stability while maintaining the look of a solid wood panel construction.
- Precision-cut cope and stick joinery for a meticulous, uncompromising look.
- The strength and durability of engineered stiles is employed for the ultimate in stiffness to resist bowing, twisting or warping.



TruStile Wood

Previously Woodharbor

- Parts are tested and sorted into a premium mix of components that exceed industry standards. All components are blended for color and grain pattern matching.
- Edge-glued solid wood panels for a premium look and feel.
- Traditional dowel construction creates a solid joint.
- An engineered stave lumber core is cut to size with alternating grain patterns, which balances the core and reduces wood's natural tendency to move.



TruColor Hand-Matched Veneers

TruStile created a proprietary color matching and grading system to ensure only the best veneers and lumber are used to handcraft your door. Based on the AWI AA Premium Grade standard, but taken a step further, TruStile Reserve Doors are unmatched in beauty.

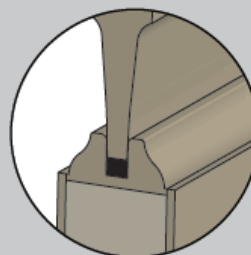

Floating Panel System

TruStile wood doors are engineered with a unique floating panel system that allow expansion and contraction while securing the panel to prevent shifting, settling and rattling. Flexible cushions are inserted between the sticking and panels. This allows the wood to expand and contract while holding the panel in position.

DOOR TERMS + DEFINITIONS

**1. FRAME**

The door frame includes the head jamb across the top, side jambs, and the sill at the bottom. Marvin frames are built strong to stand up to heavy door usage year after year.

2. STILES + RAILS

The horizontal wood members of a door are called rails; the vertical components are called stiles. With a traditional French door design, the bottom rail is about 8 inches high, with 4 ¾ inch stiles and top rail. Doors with a more contemporary style often feature more glass, with stiles and rails as sleek as 3 inches.

3. SILL

Our door sills are made of Ultrex®, our proprietary pultruded fiberglass that is exceptionally strong and virtually impervious to time, weather, and pressure. Ultrex door sills provide excellent performance in hot or cold climates, plus durability over the long haul by being resistant to warping, denting, and fading.

4. PANELS

In a door, the panel is the main section, operating or stationary, that is installed into the frame. Marvin doors come in many sizes, some of the industry's largest, and all share the tight tolerances for fit and quality finishes.

DOOR OPERATING STYLES



OUTSWING DOOR
Single or double swinging doors open to the exterior.



INSWING DOOR
Single or double swinging doors open to the interior.



SLIDING DOOR
Save space with a door panel that operates by sliding along a track.



BI-FOLD DOOR
This door folds open and closed like an accordion and can include up to 16 panels.



LIFT AND SLIDE DOOR
For openings as large as 48 feet wide and 12 feet high, substantial door panels fully open into pocket or stacked configurations.



MULTI-SLIDE DOOR
Another option to blend interior and outdoor living with a modular frame system.

EXTERIOR FINISH OPTIONS

STONE WHITE

COCONUT CREAM

SIERRA WHITE

CASHMERE

PEBBLE GRAY

HAMPTON SAGE

CADET GRAY

CLAY

DOOR FEATURES + OPTIONS



BEAUTY WITH PERFORMANCE

Designed for durability and to minimize air and water infiltration. Many of our door products are certified to a light commercial rating of PG40.

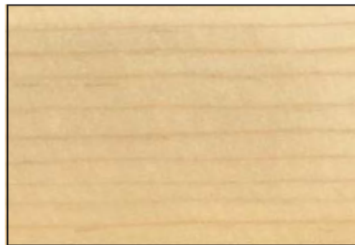

SOLID WOOD PANELS + FRAMES

The sound of a Marvin door closing is a quiet statement of quality. Wood in the panels and frames make for an elegant, crafted look and feel, and provide a weather-tight closure for outstanding energy efficiency.*

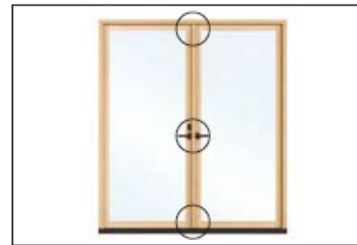

MULTI-POINT LOCKING SYSTEM

Concealed stainless steel head and foot bolts within the door secure it solidly at three points. Choose either a keyed or non-keyed lever handle. Multi-point lock comes standard.

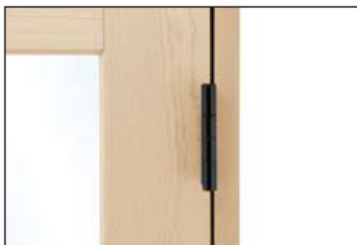

ADJUSTABLE HINGE

Standard on swinging doors, an adjustable hinge makes it easy to fine-tune the fit of a swinging door over the door's lifetime. Available in a variety of finishes, plus coastal options.

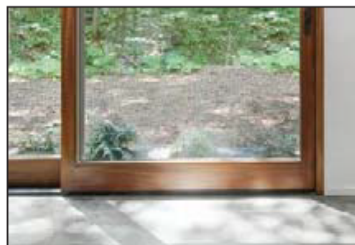

LOW PROFILE SILL

This innovative sill option on select door types provides for a smooth transition between exterior and interior.



RAISED AND FLAT PANELS

Raised and flat panels add depth and style to sliding and swinging French doors, including arch top swinging doors. This option changes the overall aesthetic of your door when less than a full lite of glass is desired.

EXTERIOR FINISH OPTIONS

- STONE WHITE
- COCONUT CREAM
- SIERRA WHITE
- CASHMERE
- PEBBLE GRAY
- HAMPTON SAGE



SERIES 10

Catalog #		Type
Project	Ulrika Plaza Building 2	
Description		Date

ARM MOUNT

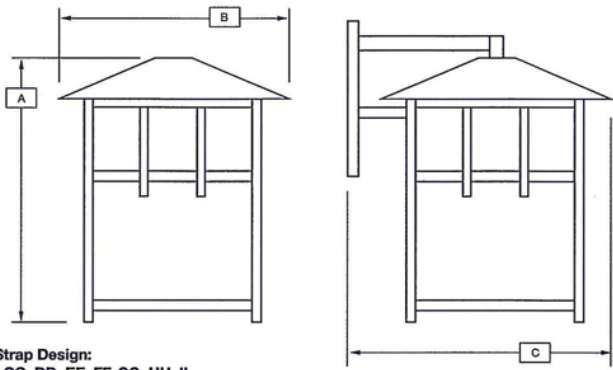

Select Strap Design:
AA, BB, CC, DD, EE, FF, GG, HH, II

Standard Features

Material
Paintlok sheet; Standard Powdercoat Finish, White Acrylic Lens; .125 thickness, ETL Wet Location.

Installation
Mounting/wireway hole in center of backplate. Supplied with standard mounting hardware to mount to a 4" J-box or plaster ring.

Optics*
Contact Evergreen Lighting for complete photometrics.

LED Features

LED
Alta LED #AL-R-1W-30LED array to be mounted onto an Aluminum MPCB Board configured to the proper wattage. The LED arrays will be centered within the Lens area and mounted on a white aluminum reflective plate.

Driver
Specific Drivers will be matched with each different LED array configuration/wattage.
Standard Driver Features:
• Constant Current
• 3 / 5 year warranty
• 120/277 multi-voltage power supplies
• Kelvin - 2700K, 3000K, 3500K, 4100K, 5000K

Fluorescent Features

Ballast
SC programmed electronic high power factor ballast, multivoltage 120V/277V. Lamps not included

Finishes

Ballast
Architectural Bronze (AB) Textured Gold (TG)
Textured Bronze (TBR) Metallic Nickel (MN)
Matte Black (MBK) Textured Verde Patina (TVP)
Semi Gloss Black (GBK) Satin Brass (SB)
Textured Black (TBK) Copper Vein (CV)
Textured Rust (TR) Gold Vein (GV)
Matte White (MW) Silver Vein (SV)
Textured White (TW) Chrome (CH)
Gloss White (GW) Oil Rubbed Bronze (ORB)
Metallic Grey (MG)

Options*

Emergency (EMR) Special Lens
Photocell (PC) Incandescent
Lamp Sources
Size Modifications
Vandal Proof Enclosure (VPE)

Sample Spec Number: 102103Q-AB-A-II

Part #	Lamp/Watts	Lumens	A	B	C
102103Q	13Q	800	10	7 1/2	8 1/2
102105T	26T	1800	10	7 1/2	8 1/2
102104Q	2-13Q	1600	10	7 1/2	8 1/2
102105	26Q	1800	10	7 1/2	8 1/2
102211	32T	2200	12 1/2	9 3/8	10 1/2
102204Q	2-13Q	1600	12 1/2	9 3/8	10 1/2
102206	2-26Q	3600	12 1/2	9 3/8	10 1/2
102222	42T	3200	12 1/2	9 3/8	10 1/2
102106L	6LED	600	10	7 1/2	8 1/2
102110L	10LED	1000	10	7 1/2	8 1/2
102112L	12LED	1200	10	7 1/2	8 1/2
102220L	20LED	2000	12 1/2	9 3/8	10 1/2
102224L	24LED	2400	12 1/2	9 3/8	10 1/2
102240L	40LED	4000	12 1/2	9 3/8	10 1/2
DARK SKY					
102109LS	9LED	900	10	7 1/2	8 1/2
102115LS	15LED	1500	10	7 1/2	8 1/2
102220LS	20LED	2000	12 1/2	9 3/8	10 1/2

Evergreen Lighting
1379 Ridgeway Street, Pomona, CA 91768
Ph: 909-865-5599 Fax: 909-865-5539
www.evergreenlighting.com

*Consult Factory

MADE IN CALIFORNIA



ULTIMATE CASEMENT STYLES



Casement and Picture windows with Satin Nickel hardware

MARVIN®

FULL FRAME OR NARROW FRAME

The Ultimate Casement and Ultimate Casement Narrow Frame windows are the most versatile and innovative casement windows ever produced. Ultimate Casement styles feature concealed multi-point locks, a patented Wash Mode, and durable hardware that operates smoothly even at the largest sizes.

WOOD

Wood is a premium material for windows and doors, offering classic aesthetic appeal, many options for customization, and design versatility.

We treat exposed millwork with a water repellent wood preservative to help it last longer. Choose from one of the four options below. Each is ready to be finished to match your project's exacting requirements.

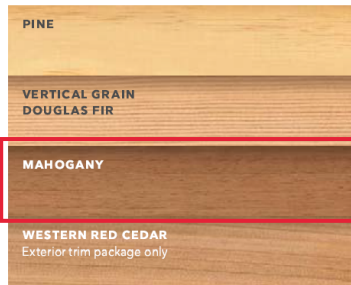

ULTIMATE CASEMENT

A recessed sash for a traditional look, plus a full jamb, offers design flexibility for new construction or full frame replacement.



ULTIMATE CASEMENT NARROW FRAME

A flush sash to the exterior and narrow jamb depth make this window an easy choice for frame-in-frame replacement or more contemporary new construction applications.



ULTIMATE CASEMENT EXTERIOR WITH 4 1/4" FULL JAMB

JAMBS + PROFILES

The Ultimate Casement has a recessed sash for a traditional or historic look. The Ultimate Casement Narrow Frame has a flush-to-frame sash for a contemporary look.



ULTIMATE CASEMENT NARROW FRAME EXTERIOR WITH 2 1/4" NARROW JAMB

ULTIMATE SWINGING NARROW PROFILE DOOR



Inswing door in Hazelnut with unequal panel widths and Matte Black hardware

MARVIN®



Inswing Door in Pine with Matte Black hardware

ULTIMATE SWINGING NARROW PROFILE DOOR

The Ultimate Swinging Narrow Profile Door, available in both Inswing and Outswing, is expertly crafted to provide industry-leading performance with narrow sightlines and robust 2 ¼ inch standard panel thickness. Featuring contemporary 3 inch stiles and rails along with square interior and exterior profiles. Choose from one or two operating panels in configurations up to 4 panels. Sizes up to 10 feet high and 14 feet wide.

WOOD

Wood is a premium material for windows and doors, offering classic aesthetic appeal, many options for customization, and design versatility. We treat exposed millwork with a water repellent wood preservative to help it last longer. Choose from one of the four options below. Each is ready to be finished to match your project's exacting requirements.

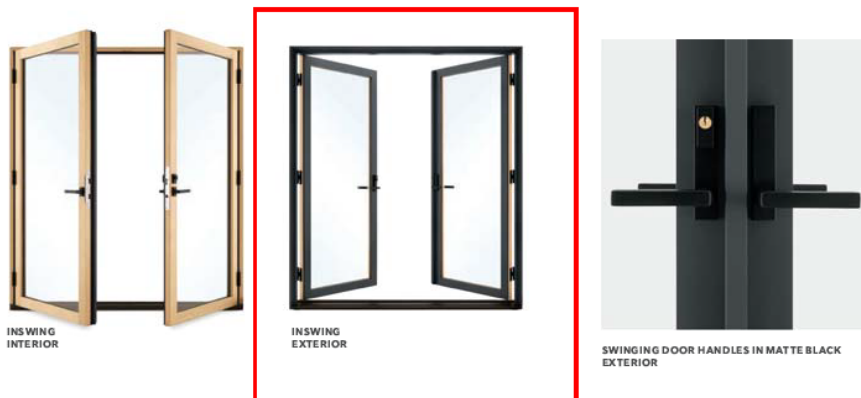
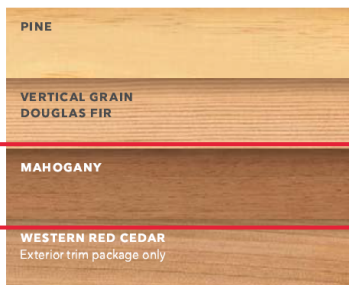

Halquist (/)

- Request a Brochure (/catalog)
- Contact Us (/contact)
- News & Events (/company/news-events)

NATIONWIDE PRODUCTS | **WISCONSIN LOCAL PRODUCTS** | **LEARN**
DEALER LOCATOR ([HTTPS://WWW.HALQUISTSTONE.COM/DEALER-LOCATOR](https://www.halquiststone.com/dealer-locator)) | **RESOURCES**

REQUEST A BROCHURE ([/CATALOG](/catalog)) | **CONTACT US ([/COMPANY/CONTACT](/company/contact))**
NEWS & EVENTS ([/COMPANY/NEWS-EVENTS](/company/news-events))

Home (<https://www.halquiststone.com/>)

/ Nationwide Products (<https://www.halquiststone.com/nationwide-products>)

/ Cut Stone (<https://www.halquiststone.com/nationwide-products/cut-stone>) / Lisbon Bianco

Lisbon Bianco Cut Stone

🔍 View sample larger (https://www.halquiststone.com/download_file/view/2038/482)

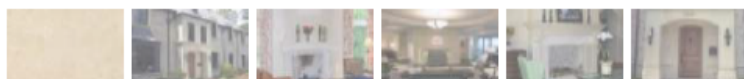

As one of the largest fabricators of cut stone in the Midwest, Halquist combines modern technology with traditional craftsmanship to bring your unique vision to reality. In addition to processing our quarried products from our nine quarries, Halquist fabricates sandstones, granites, marbles and other limestones from around the world. Our staff can help you with shop drawings, drafting and even help architects engineer a stone cladding project.

Available Finishes: polished, honed, brushed, bushhammered, sandblasted
 interior use

03 BUILDING 3













BUILDING 1

BUILDING 2

BUILDING 3

BUILDING 4

COMMON AREA

Image	Key	Item	Manufacturer	Type	Color
	RF3-1	Clay Tile Roof	Ludowici	Clay Tile Roof	Multi-Blend
	G3-1	Gutter	K&M Sheet Metal	5" 24 Ga. Galv. Single Bead Half Round	Paint to Match P3-1
	G3-2	Conductor	K&M Sheet Metal	Galv. Royal 3" Diameter	Paint to Match CT3-1
	P3-1	Exterior Paint - Cement Plaster	Benjamin Moore		Devon Cream 914
	CS3-1	Pilasters	Custom Fabricated	Cement Plaster	Smooth Finish
	CT3-1	Exterior Paint - Wood Balcony Beams & Posts	Benjamin Moore		Hasbrouk Brown HC-71
	CT3-2	Exterior Paint - Wood Balcony Pickets	Benjamin Moore		Hasbrouk Brown HC-71
	W3-1	Windows - Residential	Marvin	Ultimate Series	Sage
	D3-1	Doors - Residential	TruStyle Single Panel	Semi-Gloss	Paint to Match W3-1
	D3-2	Sliding Patio Doors - Residential	Marvin	Ultimate Series	Paint to Match W3-1
	D3-3	Single French Doors - Residential	Marvin	Ultimate Series	Paint to Match W3-1
	SF3-1	Storefront Windows	Marvin	Ultimate Series	Mahogany
	SF3-2	Storefront Doors	Marvin	Ultimate Series	Mahogany
	L3-1	Exterior Light Fixtures	Evergreen Lighting	Florence FLO2115LS	Architectural Bronze
	L3-2	Exterior Light Fixtures	BEGA	Recessed Downlight 55 291 K27	Bronze
	RP3-1	Raised Planters	Caartile	Spanish Tile	MultiColor

LEGACY COLLECTION

CUBANA 18 3/8" BARREL TILE



Ludowici's Cubana barrel tile is a truly unique system comprised of 18 3/8" tapered pans and tapered covers. The smooth finish tile can be customized to complement a variety of design styles, from rustic to clean-line contemporary. Cubana tiles are available in all standard and custom colors, mists and blends offered by Ludowici. See the *Colors of Ludowici* brochure for more information about our extensive color program.

PHYSICAL CHARACTERISTICS

CHARACTERISTIC	CUBANA 18 3/8" BARREL TILE	PROFILE
Weight Per Square	1200 lbs.	
Pieces Per Square	170 pcs.	
Overall Size	8 1/4" x 18 3/8"	
Exposure	11" C.C. x 15 3/8"	
Installed Barrel Height Off Deck	4 3/8" Nominal	
Minimum Slope	5:12	
Color Blends	Available in all standard and custom colors. For more information about Ludowici's color program, please see the <i>Colors of Ludowici</i> brochure.	
Base Texture	Smooth Also available in custom textures. * Please see the <i>Terra Cotta Textures</i> brochure for more information.	

APPROVALS & CERTIFICATIONS

- ◆ Miami-Dade NOA No: 12-0904.17
- ◆ State of Florida Approval No: FL 13777
- ◆ ASTM C1167 Grade 1 Roof Tile With Water Absorption Less Than 2%
- ◆ Class A Fire Rated
- ◆ IAPMO UES ER-452

*Textures include battered butt, brushed butt, hand roughed, hand slushed, top sand and weathered. Please see a sales representative for more details.

Photos are for representation purposes only and should not be used for final product selection. Tiles ordered should be chosen from actual samples available at the time of order. Ludowici reserves the right to alter and adjust products, colors and finishes at any time. Please contact a sales representative for more information.

LUDOWICI WARRANTY

All Ludowici tiles are manufactured in the United States and carry a 75-year warranty against color fading and manufacturing defects. For complete warranty details, please visit www.ludowici.com.



GREEN ATTRIBUTES

Ludowici terra cotta is an energy-efficient, sustainable choice for your new roof. Learn more about our green story in the Ludowici *Green Promise* brochure.



CUBANA 18 3/8" BARREL TILE

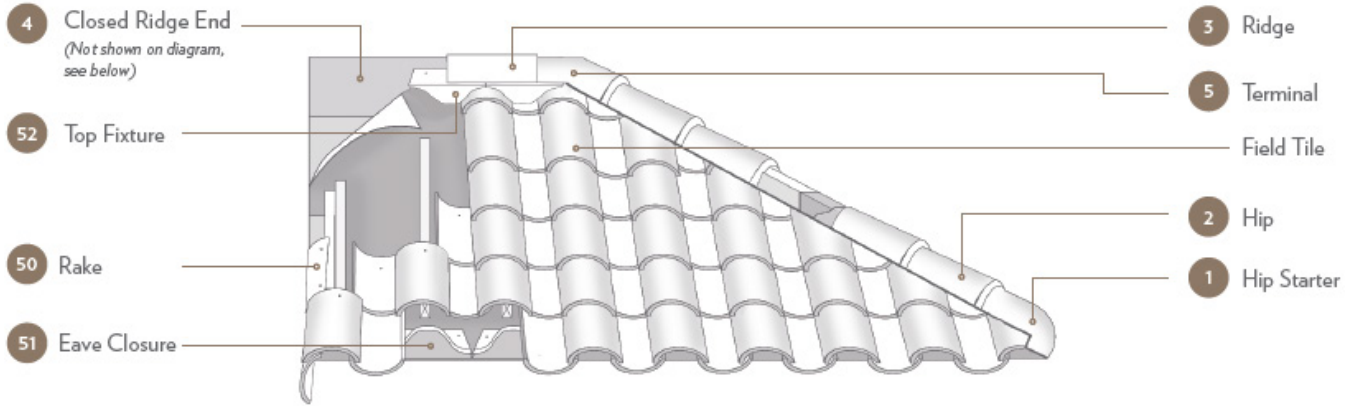

HIP & RIDGE							
Visit www.ludowici.com to download a detailed product sheet on Hip, Ridge and Decorative Hip Starters.							
	1	2	3	4	5		
PROFILE	HIP STARTER	HIP	RIDGE	CLOSED RIDGE END	TERMINAL		
Circular Cover Hip & Ridge Trim Group	 CC-Hip Starter	 CC-Hip	 CC-Ridge	 CC-Closed Ridge End	 2 Hip 1 Ridge Terminal	 2 Hip 1 Ridge Terminal	
#102/#206 Hip & Ridge Trim Group	 #152 Hip Starter	 #102 Hip Roll	 #206 Ridge	 #206 Closed Ridge End	 #102/#206 2 Hip 1 Ridge Terminal	 #405 High Bump 2 Hip 1 Ridge Terminal	 #406 High Bump Gable Terminal

FITTINGS			
	50	51	52
PROFILE	ROLLED RAKE	EAVE CLOSURE	TOP FIXTURE
Length	18 3/8"	10 11/16"	8 7/8"
Exposure	15 3/8"	11"	11"
Weight	7.1 lbs./pc.	1.7 lbs./pc.	1.7 lbs./pc.



Euro Bead Galvalume Half Round Gutter



Specifications

- Size 5", 6", 7" and 7.6"
- Lengths: 10' and 19.5'
- Material Thickness: 24 gauge



Galvalume Plus



The Royal Conductor Head

Available Downspout Options

- 3" Oval Outlet for 2"x3" Square or 3" Round Downspout
- 4" Oval Outlet for 3"x4" Square or 4" Round Downspout
- 5" Oval Outlet for 4"x5" Square or 5" Round Downspout
- 6" Oval Outlet for 4"x6" Square or 6" Round Downspout

Available Materials

- Copper 16 oz. & 20oz.
- LCC 16 oz. & 20 oz.
- Freedom Gray® 16 oz. & 20oz.
- Zinc 0.7mm & 0.8mm

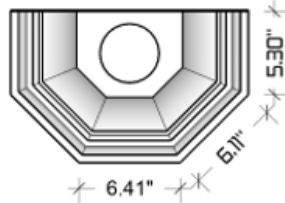

Stainless Steel

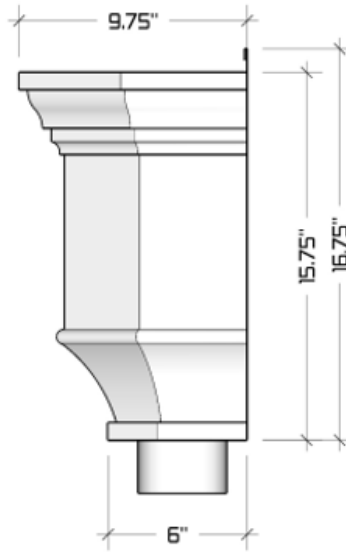
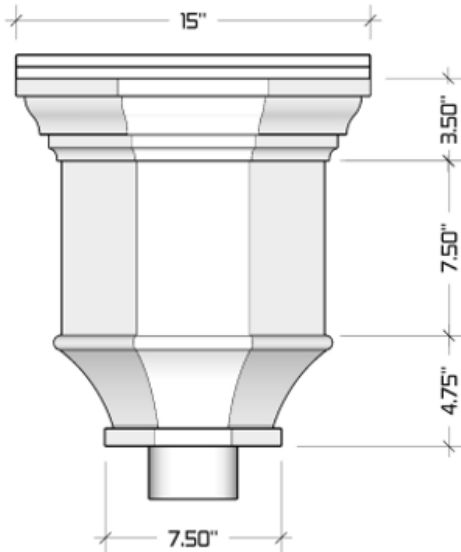

K&M SHEET METAL
 1310 E. Cornwallis Rd.
 Durham, NC - 27713
 (919) 544-8887 - Fax: 544-8898
 info@kmsheetmetal.com - www.kmsheetmetal.com

The Royal
 Conductor Head

REVISIONS	
NO.	REVISIONS
1	ORIGINAL DRAFT OF DRAWING
2	
3	
4	
5	

D 001

P3-1

- Exterior Paint - Cement Plaster

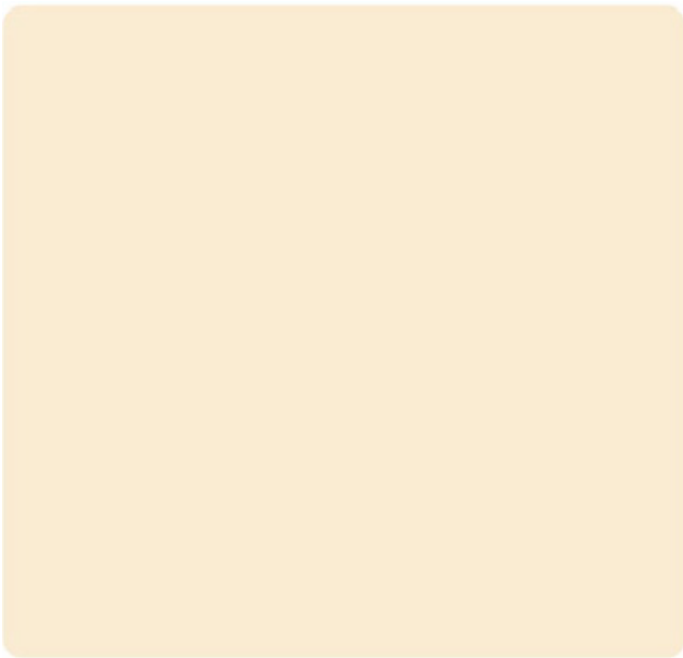

Benjamin Moore

Devon Cream: 914

914

 Sample Ships Overnight

BUILDING 1

BUILDING 2

BUILDING 3

BUILDING 4

COMMON AREA

CT3-1, CT3-2

Exterior Paint - Wood Balcony
Beams, Posts & Pickets

BUILDING 1

BUILDING 2

BUILDING 3

BUILDING 4

COMMON AREA



Benjamin Moore

Hasbrouck Brown: HC-71

HC-71

✔ Sample Ships Overnight

Light Reflectance Value: 7.630

Description: An exact color match to that impeccably polished mahogany table you covet of your grandmother's. A beautifully burnished brown with warm red undertones.

Collection Name: Historical

Approximate Sample Size: 8 in x 9.25 in

- ✔ Residential Use
- ✔ Commercial Use

ULTIMATE CASEMENT STYLES



Casement and Picture windows with Satin Nickel hardware

MARVIN®

FULL FRAME OR NARROW FRAME

The Ultimate Casement and Ultimate Casement Narrow Frame windows are the most versatile and innovative casement windows ever produced. Ultimate Casement styles feature concealed multi-point locks, a patented Wash Mode, and durable hardware that operates smoothly even at the largest sizes.

EXTERIOR FINISH OPTIONS

STONE WHITE

COCONUT CREAM

SIERRA WHITE

CASHMERE

PEBBLE GRAY

HAMPTON SAGE

CADET GRAY

CLAY



ULTIMATE CASEMENT
A recessed sash for a traditional look, plus a full jamb, offers design flexibility for new construction or full frame replacement.

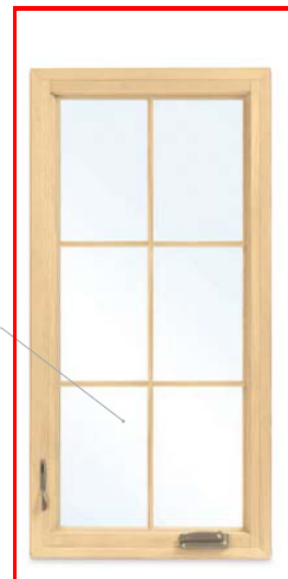

ULTIMATE CASEMENT NARROW FRAME
A flush sash to the exterior and narrow jamb depth make this window an easy choice for frame-in-frame replacement or more contemporary new construction applications.



ULTIMATE CASEMENT EXTERIOR WITH 4 1/4" FULL JAMB

JAMBS + PROFILES
The Ultimate Casement has a recessed sash for a traditional or historic look. The Ultimate Casement Narrow Frame has a flush-to-frame sash for a contemporary look.



ULTIMATE CASEMENT NARROW FRAME EXTERIOR WITH 2 1/4" NARROW JAMB

TRUSTILE
A MARVIN BRAND

WOOD DOOR CONSTRUCTION



TruStile Reserve™ Wood

Engineered to the highest quality, TruStile Reserve™ Wood Doors blend the latest technological advances with the most stringent visual appearance standards in the industry.

TruStile stain-grade doors have the shortest and most reliable lead times in the industry, with most wood doors available in 3-4 weeks.

TruStile Wood

Made in the authentic stile and rail manner, TruStile Wood Doors use a premium mix of materials that exceed industry standards for a truly natural look.



www.trustile.com



TS1000

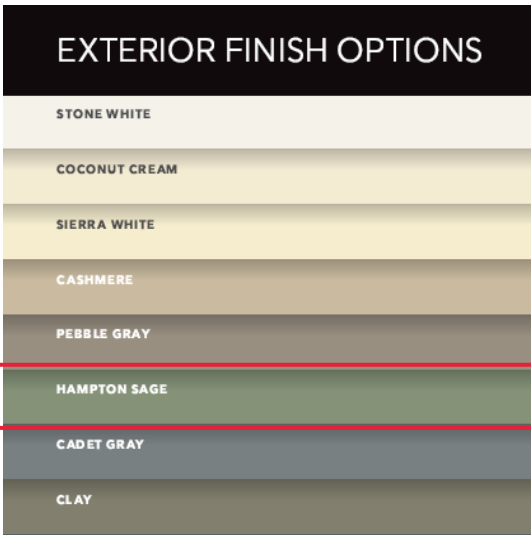
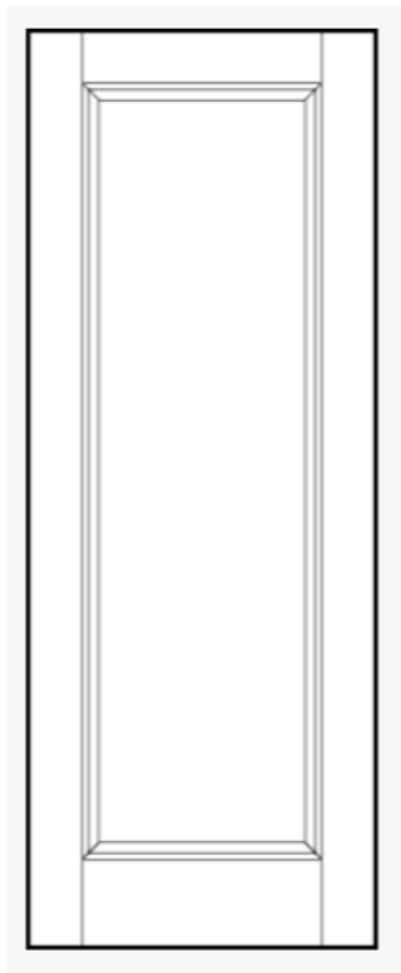

TRUSTILE
A MARVIN BRAND

WOOD DOOR CONSTRUCTION



TruStile Reserve™ Wood

Previously TruStile Wood

- The TruStile Reserve series incorporates only the finest materials and methods. We have developed a proprietary specification based on the AWI (Architectural Woodwork Institute) standard for AA Premium Grade doors.
- Engineered panel made with a composite core for strength and stability while maintaining the look of a solid wood panel construction.
- Precision-cut cope and stick joinery for a meticulous, uncompromising look.
- The strength and durability of engineered stiles is employed for the ultimate in stiffness to resist bowing, twisting or warping.



TruColor Hand-Matched Veneers

TruStile created a proprietary color matching and grading system to ensure only the best veneers and lumber are used to handcraft your door. Based on the AWI AA Premium Grade standard, but taken a step further, TruStile Reserve Doors are unmatched in beauty.



TruStile Wood

Previously Woodharbor

- Parts are tested and sorted into a premium mix of components that exceed industry standards. All components are blended for color and grain pattern matching.
- Edge-glued solid wood panels for a premium look and feel.
- Traditional dowel construction creates a solid joint.
- An engineered stave lumber core is cut to size with alternating grain patterns, which balances the core and reduces wood's natural tendency to move.

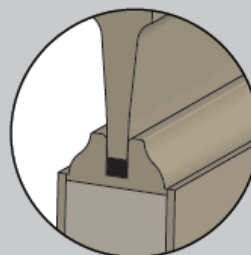

Floating Panel System

TruStile wood doors are engineered with a unique floating panel system that allow expansion and contraction while securing the panel to prevent shifting, settling and rattling. Flexible cushions are inserted between the sticking and panels. This allows the wood to expand and contract while holding the panel in position.

DOOR TERMS + DEFINITIONS

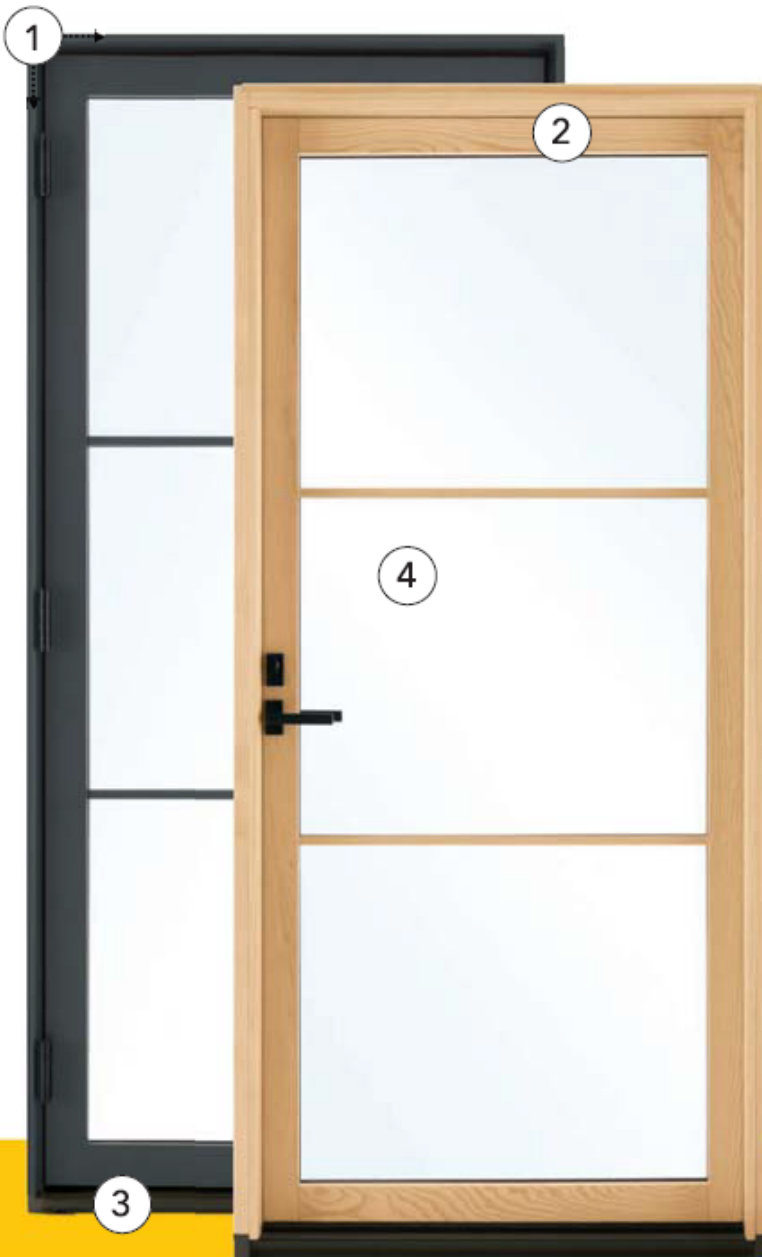
**1. FRAME**

The door frame includes the head jamb across the top, side jambs, and the sill at the bottom. Marvin frames are built strong to stand up to heavy door usage year after year.

2. STILES + RAILS

The horizontal wood members of a door are called rails; the vertical components are called stiles. With a traditional French door design, the bottom rail is about 8 inches high, with 4 $\frac{3}{4}$ inch stiles and top rail. Doors with a more contemporary style often feature more glass, with stiles and rails as sleek as 3 inches.

3. SILL

Our door sills are made of Ultrex®, our proprietary pultruded fiberglass that is exceptionally strong and virtually impervious to time, weather, and pressure. Ultrex door sills provide excellent performance in hot or cold climates, plus durability over the long haul by being resistant to warping, denting, and fading.

4. PANELS

In a door, the panel is the main section, operating or stationary, that is installed into the frame. Marvin doors come in many sizes, some of the industry's largest, and all share the tight tolerances for fit and quality finishes.

DOOR OPERATING STYLES



OUTSWING DOOR
Single or double swinging doors open to the exterior.



INSWING DOOR
Single or double swinging doors open to the interior.



SLIDING DOOR
Save space with a door panel that operates by sliding along a track.



BI-FOLD DOOR
This door folds open and closed like an accordion and can include up to 16 panels.



LIFT AND SLIDE DOOR
For openings as large as 48 feet wide and 12 feet high, substantial door panels fully open into pocket or stacked configurations.



MULTI-SLIDE DOOR
Another option to blend interior and outdoor living with a modular frame system.

EXTERIOR FINISH OPTIONS

STONE WHITE

COCONUT CREAM

SIERRA WHITE

CASHMERE

PEBBLE GRAY

HAMPTON SAGE

CADET GRAY

CLAY

DOOR FEATURES + OPTIONS



BEAUTY WITH PERFORMANCE

Designed for durability and to minimize air and water infiltration. Many of our door products are certified to a light commercial rating of PG40.

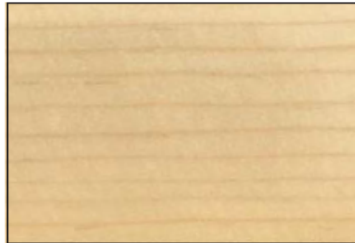

SOLID WOOD PANELS + FRAMES

The sound of a Marvin door closing is a quiet statement of quality. Wood in the panels and frames make for an elegant, crafted look and feel, and provide a weather-tight closure for outstanding energy efficiency.*

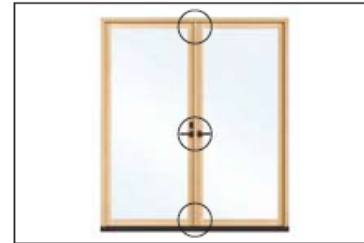

MULTI-POINT LOCKING SYSTEM

Concealed stainless steel head and foot bolts within the door secure it solidly at three points. Choose either a keyed or non-keyed lever handle. Multi-point lock comes standard.



ADJUSTABLE HINGE

Standard on swinging doors, an adjustable hinge makes it easy to fine-tune the fit of a swinging door over the door's lifetime. Available in a variety of finishes, plus coastal options.

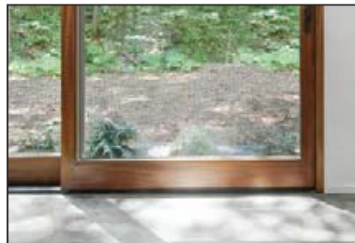

LOW PROFILE SILL

This innovative sill option on select door types provides for a smooth transition between exterior and interior living spaces.



RAISED AND FLAT PANELS

Raised and flat panels add depth and style to sliding and swinging French doors, including arch top swinging doors. This option changes the overall aesthetic of your door when less than a full lite of glass is desired.

EXTERIOR FINISH OPTIONS

STONE WHITE

COCONUT CREAM

SIERRA WHITE

CASHMERE

PEBBLE GRAY

HAMPTON SAGE

ULTIMATE CASEMENT STYLES



Casement and Picture windows with Satin Nickel hardware

MARVIN®

FULL FRAME OR NARROW FRAME

The Ultimate Casement and Ultimate Casement Narrow Frame windows are the most versatile and innovative casement windows ever produced. Ultimate Casement styles feature concealed multi-point locks, a patented Wash Mode, and durable hardware that operates smoothly even at the largest sizes.

WOOD

Wood is a premium material for windows and doors, offering classic aesthetic appeal, many options for customization, and design versatility.

We treat exposed millwork with a water repellent wood preservative to help it last longer. Choose from one of the four options below. Each is ready to be finished to match your project's exacting requirements.

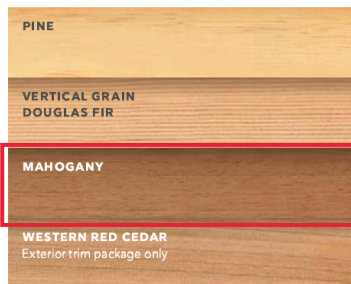

ULTIMATE CASEMENT
A recessed sash for a traditional look, plus a full jamb, offers design flexibility for new construction or full frame replacement.

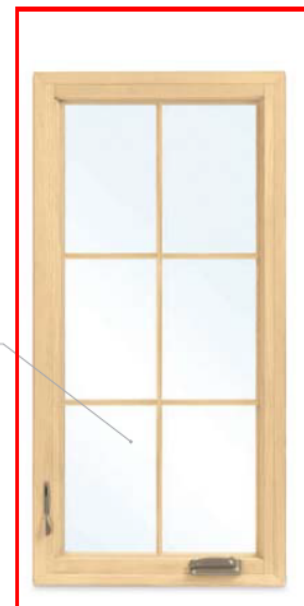

ULTIMATE CASEMENT NARROW FRAME
A flush sash to the exterior and narrow jamb depth make this window an easy choice for frame-in-frame replacement or more contemporary new construction applications.



ULTIMATE CASEMENT EXTERIOR WITH 4 1/4" FULL JAMB

JAMBS + PROFILES
The Ultimate Casement has a recessed sash for a traditional or historic look. The Ultimate Casement Narrow Frame has a flush-to-frame sash for a contemporary look.



ULTIMATE CASEMENT NARROW FRAME EXTERIOR WITH 2 1/4" NARROW JAMB

ULTIMATE SWINGING NARROW PROFILE DOOR



Inswing door in Hazelnut with unequal panel widths and Matte Black hardware

MARVIN®



Inswing Door in Pine with Matte Black hardware

ULTIMATE SWINGING NARROW PROFILE DOOR

The Ultimate Swinging Narrow Profile Door, available in both Inswing and Outswing, is expertly crafted to provide industry-leading performance with narrow sightlines and robust 2 ¼ inch standard panel thickness. Featuring contemporary 3 inch stiles and rails along with square interior and exterior profiles. Choose from one or two operating panels in configurations up to 4 panels. Sizes up to 10 feet high and 14 feet wide.

WOOD

Wood is a premium material for windows and doors, offering classic aesthetic appeal, many options for customization, and design versatility. We treat exposed millwork with a water repellent wood preservative to help it last longer. Choose from one of the four options below. Each is ready to be finished to match your project's exacting requirements.

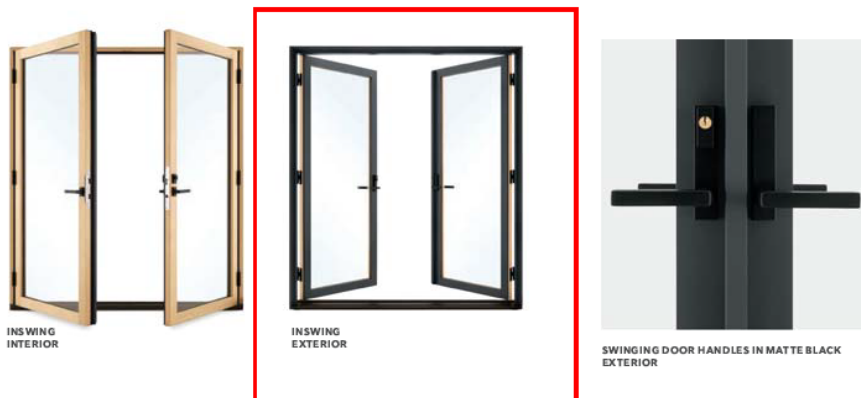
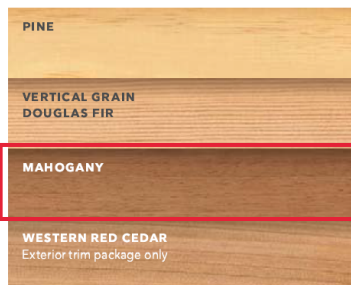



FLORENCE

Catalog #		Type
Project		
Description		Date

ARM MOUNT

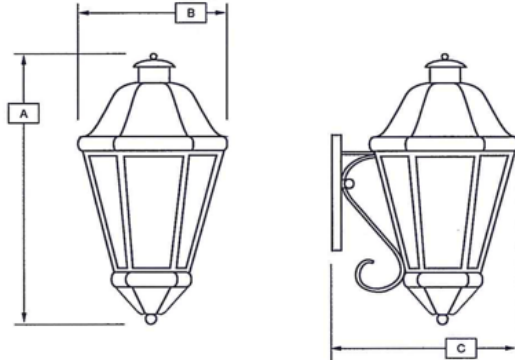

Standard Features

Material
Paintlok sheet; Standard Powdercoat Finish, White Acrylic Lens; .125 thickness, ETL Wet Location.

Installation
Mounting/wireway hole in center of backplate. Supplied with standard mounting hardware to mount to a 4" J-box or plaster ring.

Optics*
Contact Evergreen Lighting for complete photometrics.

LED Features

LED
Alta LED #AL-R-1W-30LED array to be mounted onto an Aluminum MPCB Board configured to the proper wattage. The LED arrays will be centered within the Lens area and mounted on a white aluminum reflective plate.

Driver
Specific Drivers will be matched with each different LED array configuration/wattage. Standard Driver Features:

- Constant Current
- 3 / 5 year warranty
- 120V/277 multi-voltage power supplies
- Kelvin - 2700K, 3000K, 3500K, 4100K, 5000K

Fluorescent Features

Ballast
SC programmed electronic high power factor ballast, multivoltage 120V/277V. Lamps not included

Finishes

Ballast
 Architectural Bronze (AB) Textured Gold (TG)
 Textured Bronze (TBR) Metallic Nickel (MN)
 Matte Black (MBK) Textured Verde Patina (TVP)
 Semi Gloss Black (GBK) Satin Brass (SB)
 Textured Black (TBK) Copper Vein (CV)
 Textured Rust (TR) Gold Vein (GV)
 Matte White (MW) Silver Vein (SV)
 Textured White (TW) Chrome (CH)
 Gloss White (GW) Oil Rubbed Bronze (ORB)
 Metallic Grey (MG)

Options*

Emergency (EMR) Special Lens
 Photocell (PC) Incandescent
 Lamp Sources
 Size Modifications
 Vandal Proof Enclosure (VPE)

Sample Spec Number: FLO2103Q-AB-A

Part #	Lamp/Watts	Lumens	A	B	C
FLO2103Q	13Q	800	18	11	12
FLO2105T	26T	1800	18	11	12
FLO2104Q	2-13Q	1600	18	11	12
FLO2105	26Q	1800	18	11	12
FLO2211	32T	2200	25	14	15
FLO2204Q	2-13Q	1600	25	14	15
FLO2206	2-26Q	3600	25	14	15
FLO2222	42T	3200	25	14	15
FLO2106L	6LED	600	18	11	12
FLO2110L	10LED	1000	18	11	12
FLO2112L	12LED	1200	18	11	12
FLO2220L	20LED	2000	25	14	15
FLO2224L	24LED	2400	25	14	15
FLO2240L	40LED	4000	25	14	15
DARK SKY					
FLO2109LS	9LED	900	18	11	12
FLO2115LS	15LED	1500	18	11	12
FLO2220LS	20LED	2000	25	14	15

Evergreen Lighting
 1379 Ridgeway Street, Pomona, CA 91768
 Ph: 909-865-5599 Fax: 909-865-5539
 www.evergreenlighting.com

*Consult Factory

MADE IN CALIFORNIA



Surface mounted downlight - narrow beam

Application

Compact ceiling mounted downlights designed for down lighting atriums, canopies, passages and other interior and exterior locations.

Materials

Marine grade, copper free ($\leq 0.3\%$ copper content) A360.0 aluminum alloy
 Class A toughened safety glass
 Pure anodized aluminum reflector surface
 Silicone optic with excellent high temperature and UV stability
 Silicone applied robotically to casting, plasma treated for increased adhesion

NRTL listed to North American Standards, suitable for wet locations
 Protection class IP 65
 Weight: 1.65 lbs

Electrical

Operating voltage 120-277VAC
 Minimum start temperature -30°C
 LED module wattage 8.0W
 System wattage 12.0W
 Controllability 0-10V dimmable
 Color rendering index $Ra > 80$
 Luminaire lumens 983 lumens (4000K)
 LED service life (L70) 60,000 hours

LED color temperature

- 4000K - Product number + **K4**
- 3500K - Product number + **K35**
- 3000K - Product number + **K3**
- 2700K - Product number + **K27**

BEGA can supply you with suitable LED replacement modules for up to 20 years after the purchase of LED luminaires - see website for details

Finish

All BEGA standard finishes are matte, textured powder coat with minimum 3 mil thickness. BEGA Unidure® finish, a fluoropolymer technology, provides superior fade protection in Black, Bronze, and Silver. BEGA standard White, as well as optionally available RAL and custom colors, are a polyester powder.

- Available colors Black (BLK) White (WHT) RAL:
 Bronze (BRZ) Silver (SLV) CUS:

Type:

BEGA Product:

Project: Build 3 Window

Modified:

Available options

- FSC Fusing



Surface mounted downlight - narrow beam

	LED	β	A	B	Wiring box
24 399	8.0 W	17°	3 7/8	4 3/8	19 538

β = Beam angle

BEGA 1000 BEGA Way, Carpinteria, CA 93013 (805) 684-0533 info@bega-us.com

Due to the dynamic nature of lighting products and the associated technologies, luminaire data on this sheet is subject to change at the discretion of BEGA North America. For the most current technical data, please refer to bega-us.com Updated 03/15/22 © copyright BEGA 2022

Matte California Mission Series

2 x 2

4 x 4

Decoratives stocked as shown



Alcala 2x2



Archangel 2x2



Concepcion 2x2



San Luis Rey 2x2

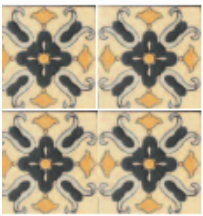

Santa Clara
4x4



San Francisco
4x4



San Juan
Capistrano 4x4



San Nicolas
4x4

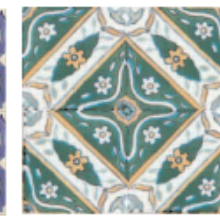

Santa Cruz
4x4

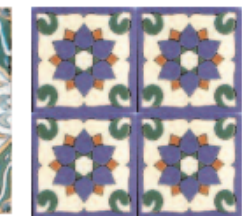

San Buenaventura
4x4



San Rafael
4x4

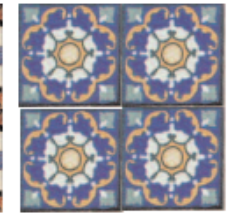

San Clemente
4x4

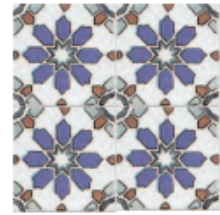

Santa Barbara
4x4

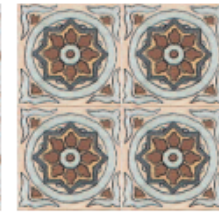

Santa Catalina
4x4

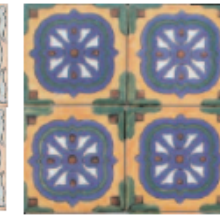

San Luis Rey
4x4

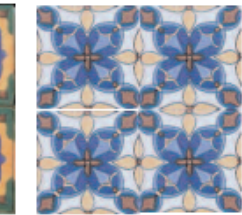

Mission Ventana
4x4



San Diego
4x4



Santa Maria
4x4

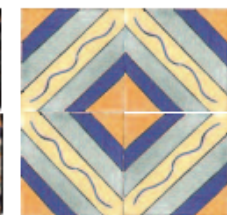

San Miguel
4x4

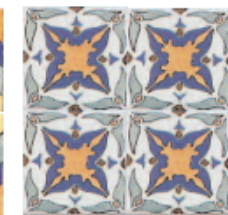

Santa Rosa
4x4

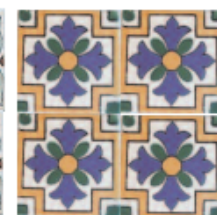

Archangel
4x4



Anacapa
4x4



San Pedro
4x4

04 BUILDING 4

















BUILDING 1

BUILDING 2

BUILDING 3

BUILDING 4

COMMON AREA

Image	Key	Item	Manufacturer	Type	Color
	RF4-1	Clay Tile Roof	Ludowici	Crude	Ebony Mist
	G4-1	Gutter	K&M Sheet Metal	24 Ga. Galv. K-Style Gutter	Van Buren Brown HC-70
	G4-2	Conductor	K&M Sheet Metal	The Excalibur Stainless Steel	Van Buren Brown HC-70
	P4-1	Board & Batt Color	Benjamin Moore		Maryville Brown HC-75
	BF4-1	Brick Façade	Historical Bricks	Clinker Brick	
	CS4-1	Cast Stone Surround	Custom Fabrication	Cast Stone	
	STC4-1	Stucco	Stucco Italiano		Terracotta
	WT4-1	Wood Trim	Benjamin Moore		Van Buren Brown HC-70
	W4-1	Windows - Residential	Marvin	Ultimate Series	Suede Clad
	D4-1	Doors - Residential	TruStyle Single Panel	Semi-Gloss	Paint to Match W4-1
	D4-2	Sliding Patio Doors - Residential	Marvin	Ultimate	Paint to Match W4-1
	D4-3	Single French Doors - Residential	Marvin	Ultimate	Paint to Match W4-1
	L4-1	Exterior Light Fixture	Generation Lighting	One Light Outdoor Wall Lantern	Weathered Copper
	SF4-1	Storefront Windows	Marvin	Ultimate Casement Series	Paint to Match W4-1
	SF4-2	Storefront Doors	Marvin	Ultimate Casement Series	Paint to Match W4-1
	RP4-1	Raised Planters	Historical Bricks	Clinker Brick	

LEGACY COLLECTION

CRUDE SHINGLE TILE



Chipped corners, rounded butts and a rough stone surface give Ludowici's Crude shingle tile the authenticity and character of an Old Europe appearance. Crude shingle tiles are available in standard and custom matte colors, mists and blends. See the *Colors of Ludowici* brochure for more information about our extensive color program.

PHYSICAL CHARACTERISTICS

CHARACTERISTIC	CRUDE SHINGLE TILE	PROFILE
Weight Per Square	1935 lbs.	
Pieces Per Square	480 pcs.	
Overall Size	6" x 12" x 5/8"	
Exposure	6" x 5"	
Minimum Slope	5:12	
Color Blends	Available in all standard and custom matte colors. For more information about Ludowici's color program, please see the <i>Colors of Ludowici</i> brochure.	
Base Texture	Stone Also available in custom textures. Please see the <i>Terra Cotta Textures</i> brochure for more information.	

EBONY MIST BLEND CR/M13 MIST

Ludowici colors are not painted on the surface, but fired in under extreme temperatures to ensure they retain their original tones and hues for many years to come. Color is included in our 75-year material warranty.

For more information on Ludowici colors, please see the *Art and Science of Ludowici Color* on the back of this card.

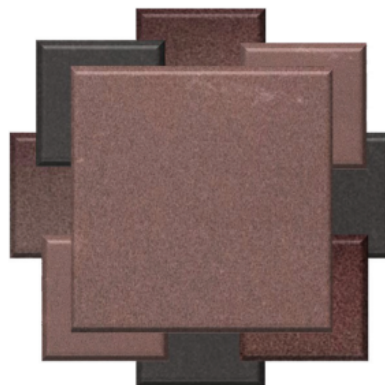

CRUDE SHINGLE TILE

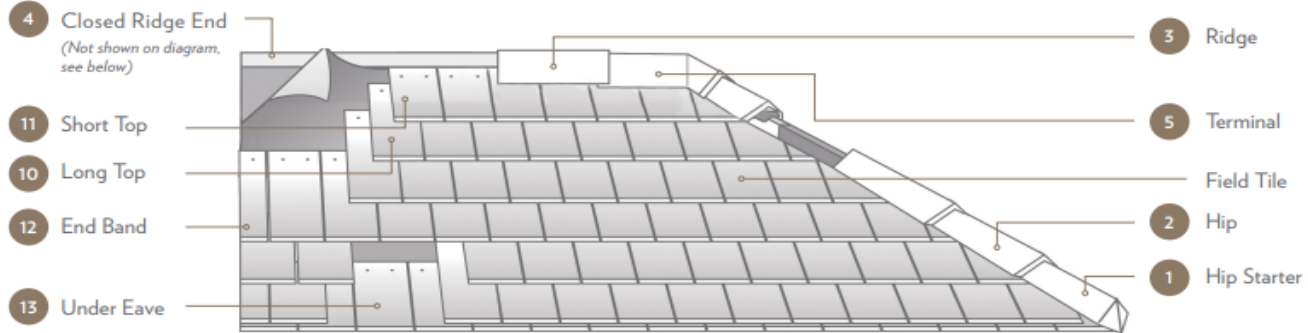

HIP & RIDGE Visit www.ludowici.com to download a detailed product sheet on Hip, Ridge and Decorative Hip Starters.

PROFILE	1 HIP STARTER	2 HIP	3 RIDGE	4 CLOSED RIDGE END	5 TERMINAL	
V-Hip & Ridge Trim Group	 V-Hip Starter	 V-Hip	 V-Ridge	 V-Closed Ridge End	 1 Ridge Terminal	
#118/#211 Hip & Ridge Trim Group	 #168 Hip Starter	 #118 Hip Roll	 #211 Ridge	 #211 Closed Ridge End	 2 Hip 1 Ridge Terminal	
Circular Cover Hip & Ridge Trim Group	 CC-Hip Starter	 CC-Hip	 CC-Ridge	 CC-Closed Ridge End	 1 Ridge Terminal	 2 Hip 1 Ridge Terminal
#102/#206 Hip & Ridge Trim Group	 #152 Hip Starter	 #102 Hip Roll	 #206 Ridge	 #206 Closed Ridge End	 2 Hip 1 Ridge Terminal	 2 Hip 1 Ridge Terminal Gable Terminal
Old Style Trim Group	 Bonnet Hip Starter*	 Bonnet Hip Roll* Aries Hip Plate*	 Interlocking Ridge			

* Roof slope on each intersecting roof plane needs to be identical to use these pieces.

FITTINGS

PROFILE	10 LONG TOP	11 SHORT TOP	12 END BAND	13 UNDER EAVE	HEADER COURSE
Actual Size	6" x 9"	6" x 5"	3" x 12"	6" x 7"	6" x 12"
Exposure	6" x 5"	6" x 2"	3" x 5"	6"	6" x 9"
Weight	3.1 lbs./pc.	1.7 lbs./pc.	2.1 lbs./pc.	3.0 lbs./pc.	4.1 lbs./pc.



24 Gauge Galvalume K-Style Gutter

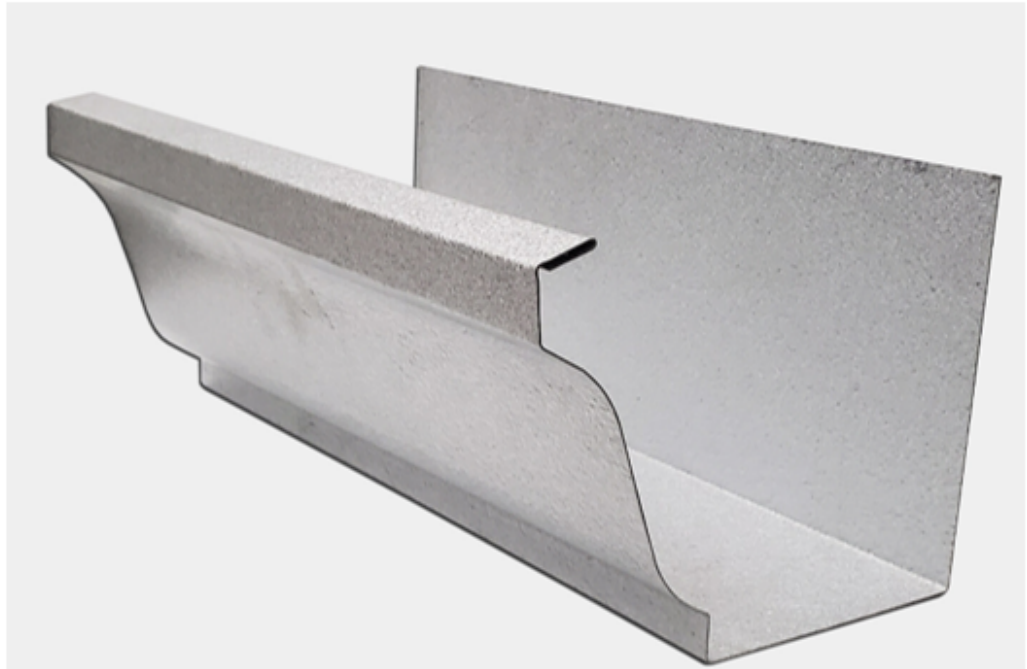

Specifications

- Size **5"** 6", 7" and 8"
- Lengths: 10' and 20'
- Material Thickness: 24 Gauge Galvalume Plus

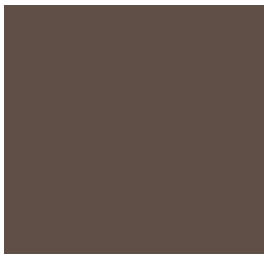

Benjamin Moore
Brunswick Beige: HC-70



Galvalume Plus



THE EXCALIBUR

-AVAILABLE IN COPPER, LEAD COATED COPPER, ZINC OR STEEL
 -CAN ACCOMMODATE 3" & 4" ROUND DOWNSPOUT
 OR 2"x3" & 3"x4" CORRUGATED OR PLAIN DOWNSPOUT

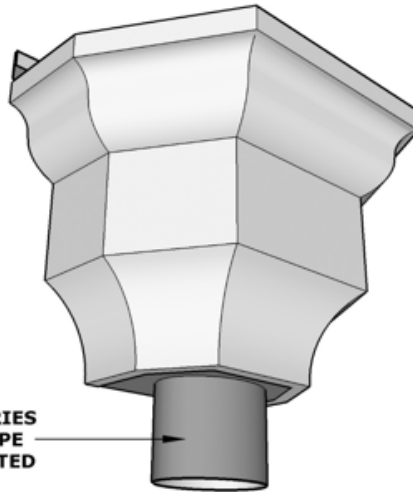

OVAL OUTLET SIZE VARIES
 DEPENDING ON THE TYPE
 OF DOWNSPOUT SELECTED

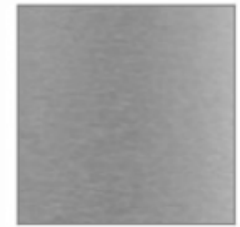

Stainless Steel

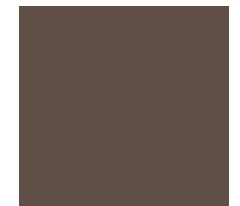

Benjamin Moore
 Brunswick Beige:
 HC-70

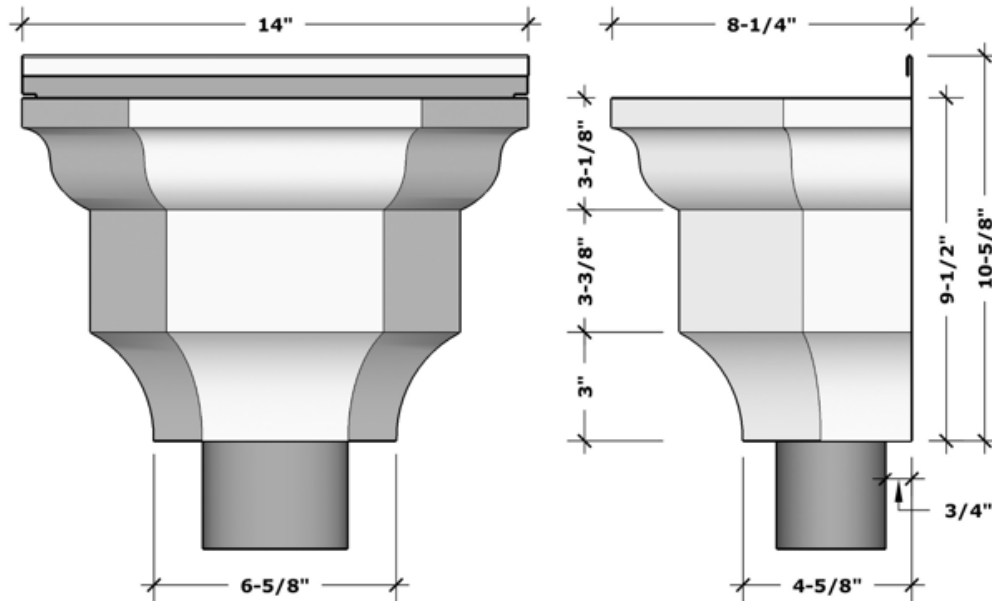

1310 E. Cornwallis Rd.
 Durham, NC 27713
 P-(919) 544-8867 F- 544-8898
 info@kmsheetmetal.com - www.kmsheetmetal.com

EXCALIBUR
 CONDUCTOR HEAD

REVISIONS	
NO.	REMARKS
1	5/2/2015 ORIGINAL DRAFT OF DRAWING
2	
3	
4	
5	

D 003

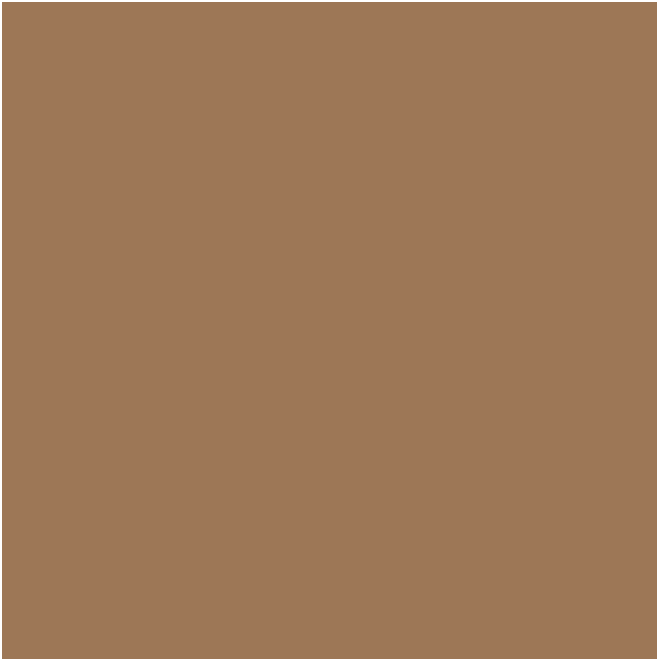

Benjamin Moore

Maryville Brown: HC-75

HC-75

Description: This color is part of the Historic Color collection. A collection of 191 time-honored hues comprises our most popular palette. Steeped in tradition, the refined, elegant colors of the Historical Collection deliver timeless color that can be used in traditional as well as contemporary spaces. Unveiled in 1976 to celebrate the US bicentennial, a collection of 191 colors inspired by America's historic landmarks.

Collection Name: Historic Color

Tudor Clinkers

[Home](#) > [Products](#) > [Antique Building Materials](#) > [Clinker Brick](#) > Tudor Clinkers

Darker tones and black burn marks and jagged remnants characterize the Tudor collection of clinker bricks, giving them an understated dignity. These brick styles for homes are often seen in the great Tudor style homes of the East Coast. A great choice to blend with existing wood or stonework and landscaping.



CS4-1

- Cast Stone Surround



BUILDING 1

BUILDING 2

BUILDING 3

BUILDING 4

COMMON AREA

Terracotta

The most typical plaster for exteriors in the Venetian tradition

This stucco is among the strongest hydrated lime-based plasters. This rugged finish contains terracotta powders. It is typically used in Venetian exteriors since it is very resistant in humid environments such that of the Venetian Lagoon.

For the application details, follow the instructions given for the application of Intonachino.

Terracotta comes in powder form in 20 kg bags or 16 kg buckets. The ecological version comes in powder in 16 kg buckets.



Exteriors & Interiors

Terracotta can be applied both on exterior and interior walls.



Ecofriendly

Terracotta is natural lime-based, and a **100% natural version is available**, excluding all chemicals.

[SEE MORE >](#)



From Rome to Venice

The curious history of a water-resistant plaster

This stucco was the first important ancient Roman plaster. The Romans discovered that by combining lime with the Terra di Pozzuoli (today pozzolana), an earth containing a large percentage of clay, they could obtain **hydraulic lime**. This type of lime hardens even underwater. This allowed them to build in the midst of rivers and in presence of large quantities of water and humidity.

In Venice, which is built on and surrounded by low waters, it was costly to bring any kind of waste out of the city. For this reason, old bricks, made of cooked clay (Terracotta in Italian), were smashed and mixed with lime to produce this red plaster. This was used on exterior walls because very resistant to the humidity levels typical of the Lagoon of Venice.



Benjamin Moore
Brunswick Beige: HC-70

HC-70

Description: This color is part of the Historic Color collection. A collection of 191 time-honored hues comprises our most popular palette. Steeped in tradition, the refined, elegant colors of the Historical Collection deliver timeless color that can be used in traditional as well as contemporary spaces. Unveiled in 1976 to celebrate the US bicentennial, a collection of 191 colors inspired by America's historic landmarks.

Collection Name: Historic Color

EXTRUDED ALUMINUM

Extruded aluminum is an extremely tough cladding that protects wood windows, mimics the profiles of wood, and provides superior durability. It is the most commonly ordered exterior material for our Ultimate products.

Select a color from our palette of 19 durable extruded aluminum colors, including a spectrum of rich hues and three pearlescent finishes. If you have more specialized needs, we can also work with you to create a custom color.

EXTERIOR FINISH OPTIONS

- PEBBLE GRAY
- HAMPTON SAGE
- CADET GRAY
- CLAY
- CASCADE BLUE
- SUEDE**
- GUNMETAL

MARVIN®



Double Hung G2 window in Ebony



Double Hung G2 window in Suede

WOOD EXTERIOR DOUBLE HUNG WINDOWS



Wood Exterior Double Hung windows with White hardware

MARVIN®



WOOD EXTERIOR DOUBLE HUNG WINDOWS

The Ultimate Wood Double/Single Hung, Ultimate Wood Double Hung Magnum, and Ultimate Wood Double Hung Insert are quintessentially American windows designed to fit seamlessly into the historic fabric of your home, neighborhood, or community. With residential and commercial applications, these windows are perfect for any historic building.



WOOD DOUBLE/SINGLE HUNG EXTERIOR



WOOD DOUBLE HUNG MAGNUM INTERIOR



DOUBLE HUNG INSERT EXTERIOR

TRUSTILE
A MARVIN BRAND

WOOD DOOR CONSTRUCTION



**TruStile
Reserve™
Wood**

Engineered to the highest quality, TruStile Reserve™ Wood Doors blend the latest technological advances with the most stringent visual appearance standards in the industry.

TruStile stain-grade doors have the shortest and most reliable lead times in the industry, with most wood doors available in 3-4 weeks.

**TruStile
Wood**

Made in the authentic stile and rail manner, TruStile Wood Doors use a premium mix of materials that exceed industry standards for a truly natural look.

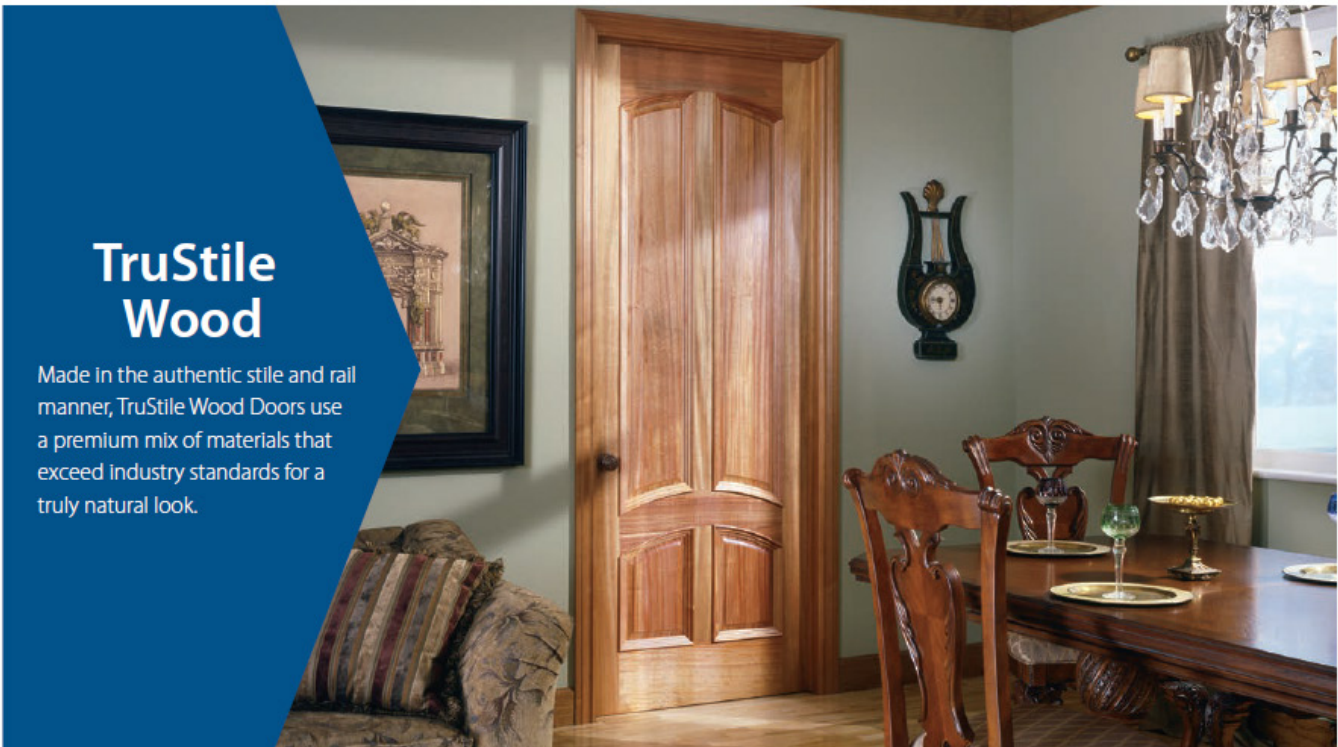

www.trustile.com

TRUSTILE[®]
A MARVIN BRAND

TS1000

EXTERIOR FINISH OPTIONS

PEBBLE GRAY

HAMPTON SAGE

CADET GRAY

CLAY

CASCADE BLUE

SUEDE

GUNMETAL

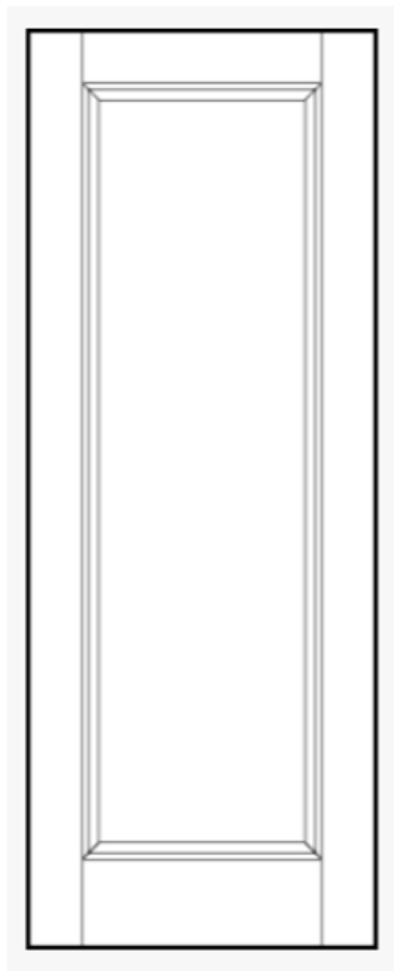

TRUSTILE
A MARVIN BRAND

WOOD DOOR CONSTRUCTION



TruStile Reserve™ Wood

Previously TruStile Wood

- The TruStile Reserve series incorporates only the finest materials and methods. We have developed a proprietary specification based on the AWI (Architectural Woodwork Institute) standard for AA Premium Grade doors.
- Engineered panel made with a composite core for strength and stability while maintaining the look of a solid wood panel construction.
- Precision-cut cope and stick joinery for a meticulous, uncompromising look.
- The strength and durability of engineered stiles is employed for the ultimate in stiffness to resist bowing, twisting or warping.



TruColor Hand-Matched Veneers

TruStile created a proprietary color matching and grading system to ensure only the best veneers and lumber are used to handcraft your door. Based on the AWI AA Premium Grade standard, but taken a step further, TruStile Reserve Doors are unmatched in beauty.



TruStile Wood

Previously Woodharbor

- Parts are tested and sorted into a premium mix of components that exceed industry standards. All components are blended for color and grain pattern matching.
- Edge-glued solid wood panels for a premium look and feel.
- Traditional dowel construction creates a solid joint.
- An engineered stave lumber core is cut to size with alternating grain patterns, which balances the core and reduces wood's natural tendency to move.

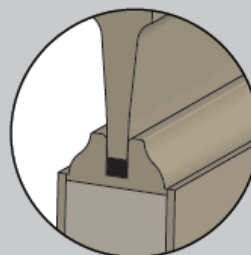

Floating Panel System

TruStile wood doors are engineered with a unique floating panel system that allow expansion and contraction while securing the panel to prevent shifting, settling and rattling. Flexible cushions are inserted between the sticking and panels. This allows the wood to expand and contract while holding the panel in position.

DOOR TERMS + DEFINITIONS

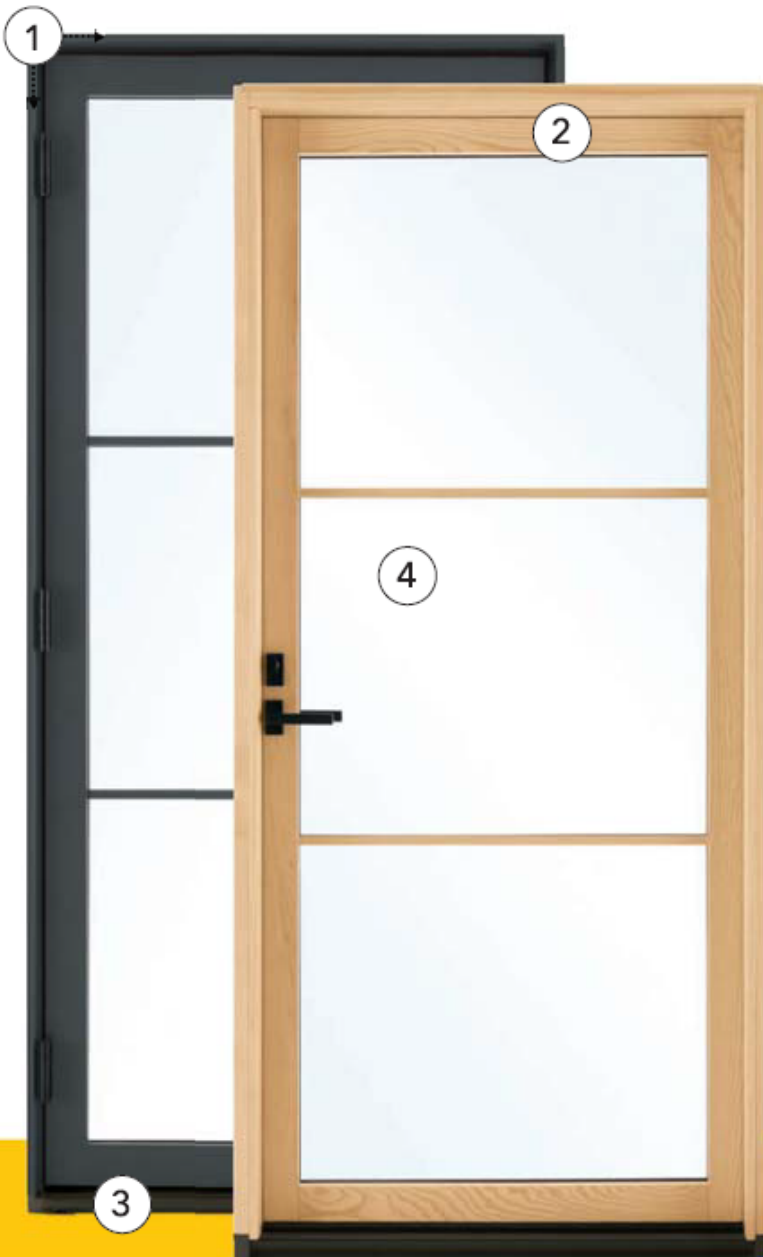
**1. FRAME**

The door frame includes the head jamb across the top, side jambs, and the sill at the bottom. Marvin frames are built strong to stand up to heavy door usage year after year.

2. STILES + RAILS

The horizontal wood members of a door are called rails; the vertical components are called stiles. With a traditional French door design, the bottom rail is about 8 inches high, with 4 $\frac{3}{4}$ inch stiles and top rail. Doors with a more contemporary style often feature more glass, with stiles and rails as sleek as 3 inches.

3. SILL

Our door sills are made of Ultrex®, our proprietary pultruded fiberglass that is exceptionally strong and virtually impervious to time, weather, and pressure. Ultrex door sills provide excellent performance in hot or cold climates, plus durability over the long haul by being resistant to warping, denting, and fading.

4. PANELS

In a door, the panel is the main section, operating or stationary, that is installed into the frame. Marvin doors come in many sizes, some of the industry's largest, and all share the tight tolerances for fit and quality finishes.

DOOR OPERATING STYLES



OUTSWING DOOR
Single or double swinging doors open to the exterior.



INSWING DOOR
Single or double swinging doors open to the interior.



SLIDING DOOR
Save space with a door panel that operates by sliding along a track.



BI-FOLD DOOR
This door folds open and closed like an accordion and can include up to 16 panels.



LIFT AND SLIDE DOOR
For openings as large as 48 feet wide and 12 feet high, substantial door panels fully open into pocket or stacked configurations.



MULTI-SLIDE DOOR
Another option to blend interior and outdoor living with a modular frame system.

EXTERIOR FINISH OPTIONS

PEBBLE GRAY

HAMPTON SAGE

CADET GRAY

CLAY

CASCADE BLUE

SUEDE

GUNMETAL

DOOR FEATURES + OPTIONS



BEAUTY WITH PERFORMANCE

Designed for durability and to minimize air and water infiltration. Many of our door products are certified to a light commercial rating of PG40.

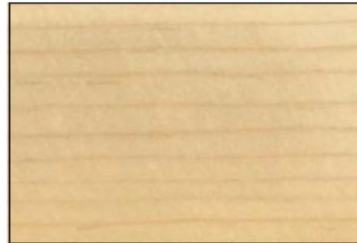

SOLID WOOD PANELS + FRAMES

The sound of a Marvin door closing is a quiet statement of quality. Wood in the panels and frames make for an elegant, crafted look and feel, and provide a weather-tight closure for outstanding energy efficiency.*

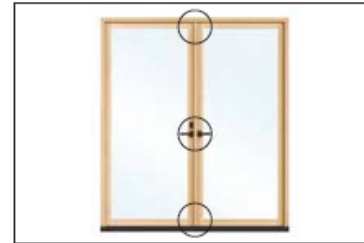

MULTI-POINT LOCKING SYSTEM

Concealed stainless steel head and foot bolts within the door secure it solidly at three points. Choose either a keyed or non-keyed lever handle. Multi-point lock comes standard.



ADJUSTABLE HINGE

Standard on swinging doors, an adjustable hinge makes it easy to fine-tune the fit of a swinging door over the door's lifetime. Available in a variety of finishes, plus coastal options.

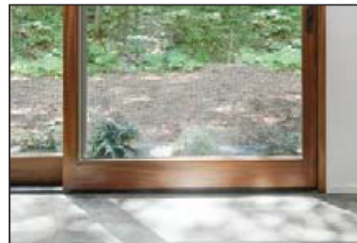

LOW PROFILE SILL

This innovative sill option on select door types provides for a smooth transition between exterior and interior living spaces.



RAISED AND FLAT PANELS

Raised and flat panels add depth and style to sliding and swinging French doors, including arch top swinging doors. This option changes the overall aesthetic of your door when less than a full lite of glass is desired.

EXTERIOR FINISH OPTIONS

HAMPTON SAGE

CADET GRAY

CLAY

CASCADE BLUE

SUEDE

GUNMETAL



A

Weathered Copper Finish (-44)
Clear Seeded Glass with White Aluminum Backing

DESIGN INFORMATION

Category	Outdoor Light
Class	Outdoor
Collection	Chatham
Finish	Weathered Copper
Fixture Type	One Light Outdoor Wall Lantern
Material	Brass

DIMENSIONS & WEIGHT

Backplate	W:4 3/4" H:8" OB UP:8 1/2" OB DOWN:12 1/2" Rectangular
Dimensions	L:9 1/4" W:9 1/4" H:21" E:10"
Extends	10
Height	21.00
Length	9.25
Weight	5.7
Width	9.25

ADDITIONAL INFORMATION

cUL Listing	cUL Wet
Mounting Procedure	Cap Nuts
UL Listing	UL Wet

**A. LARGE ONE LIGHT
OUTDOOR WALL LANTERN**

W: 9.25" H: 21" E: 10"

Height from center of outlet box
up: 8.5"

WET

8463DEN3-44(1) Med. Base LED 3000K,
9W, 800 Lumen lamp incl.

T24

ULTIMATE CASEMENT STYLES



Casement and Picture windows with Satin Nickel hardware

FULL FRAME OR NARROW FRAME

The Ultimate Casement and Ultimate Casement Narrow Frame windows are the most versatile and innovative casement windows ever produced. Ultimate Casement styles feature concealed multi-point locks, a patented Wash Mode, and durable hardware that operates smoothly even at the largest sizes.

EXTERIOR FINISH OPTIONS

PEBBLE GRAY

HAMPTON SAGE

CADET GRAY

CLAY

CASCADE BLUE

SUEDE

GUNMETAL



ULTIMATE CASEMENT

A recessed sash for a traditional look, plus a full jamb, offers design flexibility for new construction or full frame replacement.



ULTIMATE CASEMENT NARROW FRAME

A flush sash to the exterior and narrow jamb depth make this window an easy choice for frame-in-frame replacement or more contemporary new construction applications.



ULTIMATE CASEMENT EXTERIOR WITH 4 1/4" FULL JAMB

JAMBS + PROFILES

The Ultimate Casement has a recessed sash for a traditional or historic look. The Ultimate Casement Narrow Frame has a flush-to-frame sash for a contemporary look.



ULTIMATE CASEMENT NARROW FRAME EXTERIOR WITH 2 1/4" NARROW JAMB

ULTIMATE SWINGING NARROW PROFILE DOOR



Inswing door in Hazelnut with unequal panel widths and Matte Black hardware

MARVIN®



ULTIMATE SWINGING NARROW PROFILE DOOR

The Ultimate Swinging Narrow Profile Door, available in both Inswing and Outswing, is expertly crafted to provide industry-leading performance with narrow sightlines and robust 2 ¼ inch standard panel thickness. Featuring contemporary 3 inch stiles and rails along with square interior and exterior profiles. Choose from one or two operating panels in configurations up to 4 panels. Sizes up to 10 feet high and 14 feet wide.

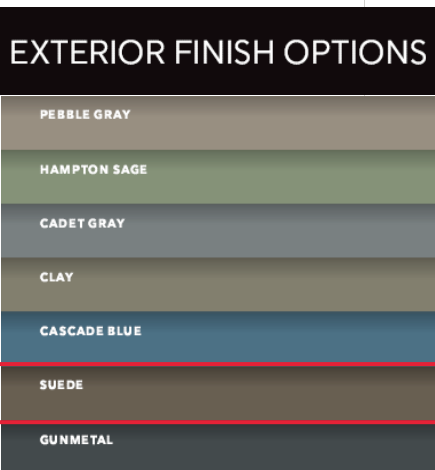

05 COMMON AREA

BUILDING 1

BUILDING 2

BUILDING 3

BUILDING 4

COMMON AREA

Image	Key	Item	Manufacturer	Type	Color
	WK-1	Flagstone Paver	Graniterock	Lompoc Stone	Country
	WK-2	Courtyard Paver	McNear	1" Pavers - Cobblestone	Charcoal/Tan
	WK-3	Precast Pavers	Pacific Interlock	HydroFlo - City Sidewalks	Monterey Sands
	P-1	Exterior Paint - Cement Plaster	Benjamin Moore		Muskoka Trail 975
	ER-1	Balcony Railing	King Metals	Wrought Iron Knotted Pickets	Double Knuckle
	ER-2	Balcony Deck Pavers	Bison	Porcelain Deck Pavers	Trust Gold 24"x24"
	ES-1	Exterior Stairs	Bretelson	Miratread	Finish to Match ER-2
	L-1	Exterior Light Fixture	WAC Lighting	Semi-Gloss	White
	L-2	Exterior Light Fixture	Spectrum Lighting	Warehouse Shade	Bronze
	F-1	Fountain Flagstone	K2	Kettle Valley Country Cottage	Random Field Stone
	MT-1	Mosaic Tile	Lunada Bay	Lapis 1x1 Offset	Fathom, Natural Finish
	P1-2	Doors - Elevator	ThyssenKrupp	Semi-Gloss	HC-105 Rockport Gray



Lompoc Stone

The Lompoc Country Flagstone is dense quarzitic dolomite limestone quarried near Lompoc, CA. Pieces will range from 8" x 8" up to 14" x 14" and are approximately 1½" to 2½" thick. This stone is sold by the pound.

*Disclaimer: Given that these are natural products, there will be variations in color, texture, veining, and patterns.

Style:

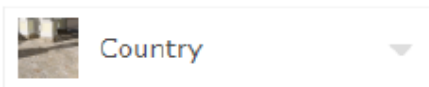



COBBLESTONE
CHARCOAL/TAN



OLD TOWN

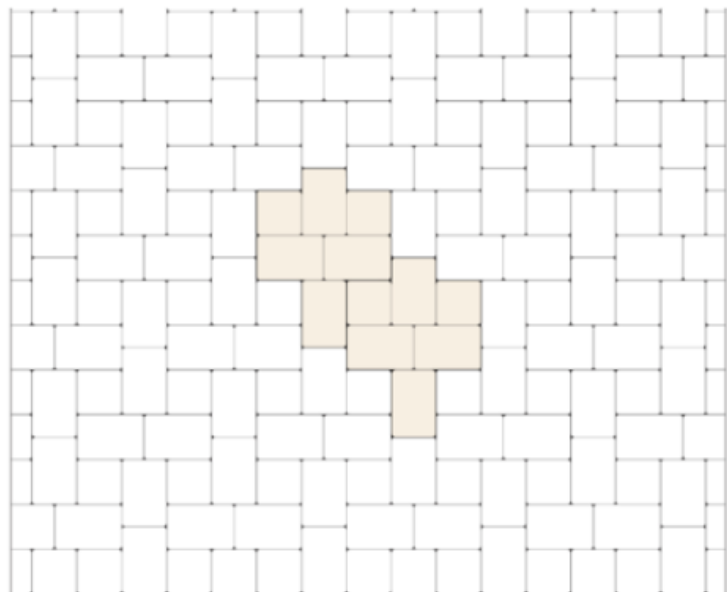

1" Pavers

1" SQUARE



1" RECTANGLE

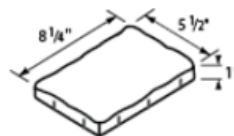



Home

HydroFlo™ Pavers

Standard Pavers

Our Colors

News and Info

Our Color Selection

Search...



S1 Red (Solid)



S2 Tan (Solid)



S3 Brown (Solid)



S4 Gray (Solid)



S5 Charcoal (Solid)



B1 Shasta Redwood (red/brown)



B2 Summit Sunrise (gray/tan/charcoal)



B3 Santa Fe Blush (red/tan)



B4 Painted Desert (red/tan/charcoal)



B5 Mojave Dunes (tan/brown)



B6 Tahoe Granite (gray/charcoal)



B7 Monterey Sand (tan/charcoal)



B8 Country Loam (brown/charcoal)



B9 Island Ember (red/charcoal)



W1 SB Tan (Santa Barbara Tan)

Phone: 831-637-9163 | info@pacinterlock.com



Home

HydroFlo™ Pavers

Standard Pavers

Our Colors

News and Info

Hydro-Flo™ City Estate Pavers



Hydro-Flo™ City Estate Pavers

The Pacific Interlock Pavers Hydro-Flo™ City Estate Permeable Paver is available in many of our most popular colors and will compliment any decor and landscape.

As with all of our Hydro-Flo™ Permeable pavers, they are virtually maintenance-free and ecologically friendly.

The Hydro-Flo™ City Estate paver comes in three sizes (Large, Medium and Small) and two thicknesses (60mm and 80mm).

Category: HydroFlo™ Series



Share On Facebook



Tweet This Product



Pin This Product



Email This Product



Pattern: Running Bond

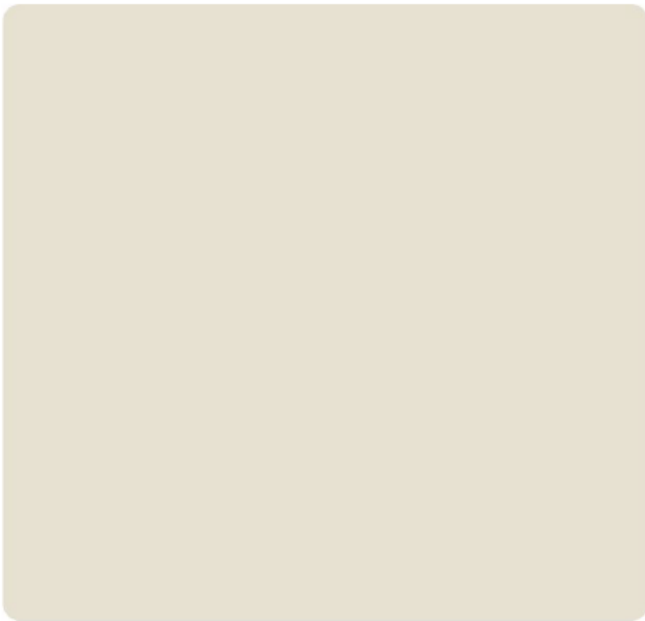

Benjamin Moore

Muskoka Trail: 974

974



 Sample Ships Overnight

Light Reflectance Value: 73.540

Description: This color is part of the Classic Color Collection. Surround yourself with your color favorites. These timeless elegant, Classic Colors guarantee beautiful, usable color all the time, every time. A collection of 1,680 inspired hues that consumers and professionals have enjoyed for years, the colors in this palette are as timeless as they are forward.

Collection Name: BM Classics

Approximate Sample Size: 8 in x 9.25 in

-  **Residential Use**
-  **Commercial Use**

ER-1

- Wrought Iron Knotted Pickets

KINGMETALS

FORGED ALUMINUM BALUSTERS

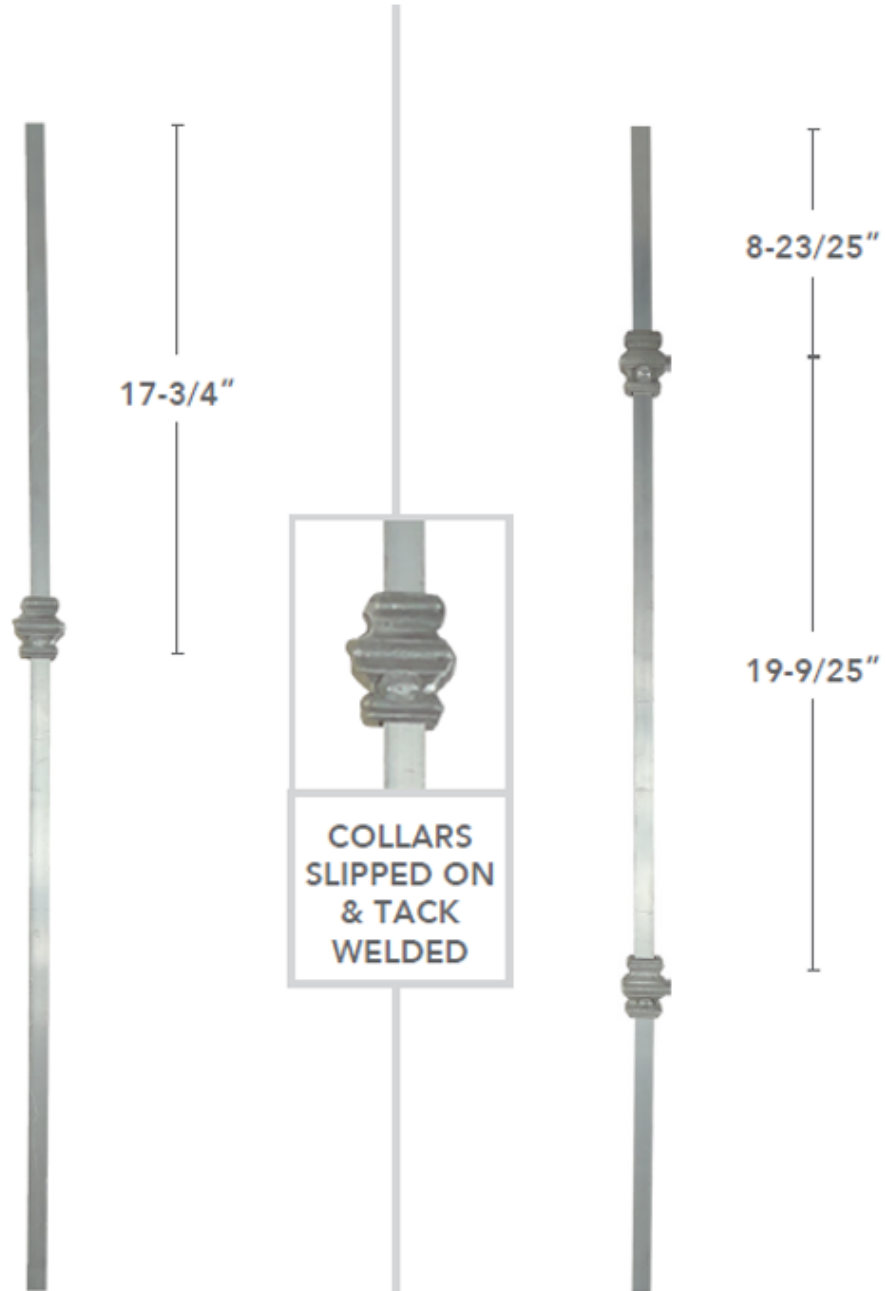

13-95725-940

↓ 45-1/4" **\$15.48 ea.**
↔ 1-9/16" **\$14.78 (10+)**
⚖ 1.45 lbs **\$14.07 (50+)**

13-95725-941

↓ 45-1/4" **\$8.27 ea.**
↔ 1-9/16"
⚖ 1.59 lbs

BUILDING 1

BUILDING 2

BUILDING 3

BUILDING 4

COMMON AREA



2CM PAVERS

August 2019

DISTINCTIVE, SOPHISTICATED, AND LIGHTWEIGHT BISON 2CM PAVERS

Bison 2CM Pavers are a beautiful surfacing option for rooftop environments. These low profile pavers combine a natural quarried stone look with handcrafted precision and performance. The Bison 2CM Paver and Paver Tray* System provides excellent weather resistance and architectural charm to rooftop decks.

- Tested for use with Bison Pedestal Systems. 2CM Pavers are slip, stain, and fade resistant.
- Beautiful Finishes. Durable and easy to clean in high traffic areas.
- Low Height Profile. 0.79" thick (1.24" with Bison Paver Tray).
- Quick and Easy to Install. Recommended for use on Bison Pedestals from 0.50" to 36" in height. Must be used with Bison Paver Tray (Model PT-TRAY-2424-3) when installed on Bison Pedestals.
- Lightweight. 9.45 psf (11.92 psf with Bison Paver Tray). Easy to lift and install.
- Commercial Grade. Great for retrofit applications.
- Made in the U.S.A.

*US Patents Pending.

©2015-2019 United Construction Products, Inc. All Rights Reserved.

Bison Innovative Products | 701 Osage Street, Unit 120, Denver CO 80204 USA | 800-333-4234 | www.bisonip.com

Photographer: Alian Jaramillo

Bison 2CM Pavers (PT-24-BISON)



AXI Brown Chestnut

Dimensions 23.54" x 23.54" x 0.79"
(598 x 598 x 20 mm)
Weight 36.38 lbs (16.50 kg)
Weight psf 9.45 psf (46.14 kg/m²)
Solar Reflectance Index 30 SRI



AXI Grey Timber

Dimensions 23.54" x 23.54" x 0.79"
(598 x 598 x 20 mm)
Weight 36.38 lbs (16.50 kg)
Weight psf 9.45 psf (46.14 kg/m²)
Solar Reflectance Index 29 SRI

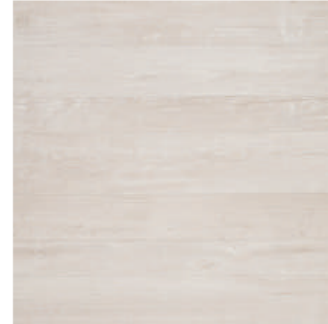

AXI White Pine

Dimensions 23.54" x 23.54" x 0.79"
(598 x 598 x 20 mm)
Weight 36.38 lbs (16.50 kg)
Weight psf 9.45 psf (46.14 kg/m²)
Solar Reflectance Index 63 SRI



Seastone Gray

Dimensions 23.54" x 23.54" x 0.79"
(598 x 598 x 20 mm)
Weight 36.38 lbs (16.50 kg)
Weight psf 9.45 psf (46.14 kg/m²)
Solar Reflectance Index 34 SRI



Block Bianco

Dimensions 23.54" x 23.54" x 0.79"
(598 x 598 x 20 mm)
Weight 36.38 lbs (16.50 kg)
Weight psf 9.45 psf (46.14 kg/m²)
Solar Reflectance Index 65 SRI



Mark Chrome

Dimensions 23.54" x 23.54" x 0.79"
(598 x 598 x 20 mm)
Weight 36.38 lbs (16.50 kg)
Weight psf 9.45 psf (46.14 kg/m²)
Solar Reflectance Index 47 SRI



Trust Silver

Dimensions 23.54" x 23.54" x 0.79"
(598 x 598 x 20 mm)
Weight 36.38 lbs (16.50 kg)
Weight psf 9.45 psf (46.14 kg/m²)
Solar Reflectance Index 41 SRI



Trust Gold

Dimensions 23.54" x 23.54" x 0.79"
(598 x 598 x 20 mm)
Weight 36.38 lbs (16.50 kg)
Weight psf 9.45 psf (46.14 kg/m²)
Solar Reflectance Index 50 SRI

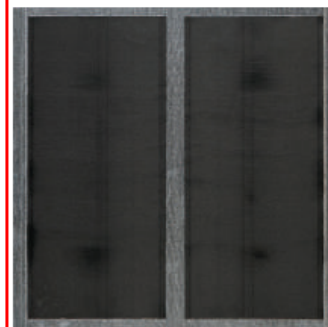

PT-TRAY-2424-3

Dimensions 23.43" x 23.43" x 0.45"
(595 x 595 x 12 mm)
Weight 9.52 lbs (4.32 kg)
Weight psf 2.47 psf (12.07 kg/m²)
Fits 595- 602 x 595- 602 mm pavers

NOTE: Bison 2CM Pavers are a natural product and vary in color. Actual colors may differ from pictures; please contact Bison for a color sample. Bison 2CM Pavers MUST be used with the Bison Paver Tray (Model PT-TRAY-2424-3) when installed on Bison Pedestals.

Bison Innovative Products | 701 Osage Street, Unit 120, Denver CO 80204 USA | 800-333-4234 | www.bisonip.com

Bison 2CM Paver Testing

Bison 2CM Pavers meet or exceed the following standards:

	Technical Features	Test Method	Requirements for nominal size N		LASTRA 20mm
			N ≥ 15 cm		
			(%)	(mm)	
Structural Characteristics	Water absorption	ASTM C373	Requirement ANSI A 137.1 Water absorption max ≤ 0.5%		≤ 0.1%
Bulk Mechanical Characteristics	Breaking strength	ASTM C648	0 ≥ S ≤ 22000 lbs		≥ 3000 lbs 24" x 24"
Surface Mechanical Characteristics	Mohs hardness/ Scratch resistance	EN 101 ⁽¹⁾	≥ 6 (UGL)		8
Thermal Characteristics	Thermal shock resistance	ISO 10545-9	Pass according to ISO 10545-1	Test method available	Resistant
Chemical Characteristics	Resistance to household chemicals and swimming pool safe	ISO 10545-13	Minimum Class B (U for unglazed tiles)		UA
	Resistance to low concentrations of acids and alkalis		Declared Class	Test method available	ULA
	Resistance to high concentrations of acid and alkalis		Declared Class	Test method available	UHA
	Resistance to staining	ISO 10545-14	Minimum Class 3		5
Safety Characteristics	Dynamic coefficient of friction (DCOF)	ANSI A137.1-2012	ANSI A.137.1 Requires a minimum value of 0.42 for commercial areas that are likely to be wet.		> 0.42 Wet

It is recommended that you order an additional 5-10% of 2CM Paver material to have on hand for breakages and paver replacement as needed. While the thickness and density of Bison 2CM Pavers make for a durable surface material, they can be damaged by mishandling or careless treatment. Please note that if tools, furnishings, or equipment are forcefully dropped on the Pedestal Paver System, chips, scratches, surface damage, and/or cracking and breakage can occur, especially in cold temperatures. Always protect the installed pavers by using sheets of plywood to cover the work area and protect the 2CM Pavers from chipping and breakage. *NOTE: Please refer to Bison Specifications, available at www.bisonip.com for more information.*



Photographer: Alian Jaramillo

Bison Innovative Products | 701 Osage Street, Unit 120, Denver CO 80204 USA | 800-333-4234 | www.bisonip.com

Bison 2CM Paver Care & Maintenance Recommendations

NOTE: This guide is intended to be used in conjunction with the most up to date version of Bison Specifications, which can be found online at www.bisonip.com.

Test any cleaners in an inconspicuous area first before applying them to the installed deck. In addition, always check with the manufacturer of your roof membrane to ensure that any cleaning solution or product will not compromise or damage the waterproofing membrane below. Remember to use safety glasses, respirators, and gloves in handling any materials that contain chemicals. Refer to product manufacturer's SDS for more information on chemical components and safe handling practices.

Visual Observation: Check for rocking pavers and adjust or shim immediately. Failure to do so can cause a tripping hazard. Periodically check spacer tabs and immediately replace broken tabs to limit deck movement. Make sure the edge restraint stays intact and structurally sound.

Cleaning: If desired, Bison 2CM Pavers can be periodically cleaned. All spills should be cleaned as quickly as possible. Sweep thoroughly and mop with a clean damp mop using a PH-balanced mild household detergent such as diluted dish soap. Rinse thoroughly with clean, clear water to remove the dirty detergent solution and emulsified soil. Rinsing is a critical step in the maintenance procedure. Remove the rinse water with a squeegee. If dirty detergent solution is not removed and is allowed to dry on the surface, a coating will form which is very difficult to remove.

Deep Cleaning: When necessary, scrub with cotton mop, cloth, sponge, or non-metallic brush. DO NOT use abrasive cleaners, brushes with hard or metal bristles, scouring pads, steel wool, or sandpaper. DO NOT use scouring powders, as these products contain abrasives that may scratch the surface of the paver, or vinegar or any cleaners containing acids or strong alkaline agents. Products with high acid or ammonia content are not recommended. Acid washing is not recommended. Acids, like orange extract and vinegar (including any substance with a PH lower than 7) can damage the glazed surface of the tile and alkaline solutions like ammonia or bleach (including any substance with a PH higher than 7) can discolor. Commercial floor scrubbers or floor buffing machines are not recommended due to their potential to damage the deck system. You may use a pressure washer to remove built-up dirt, mold, or mildew from your 2CM Pavers. A maximum of 1200 PSI is suggested for Bison 2CM Pavers. Test an inconspicuous area first and be careful to clean the entire deck to avoid lap marks.

Sealing: Applying sealer or wax to 2CM Pavers is not recommended.

Water and Snow Removal: Always rinse pavers thoroughly after any application of ice-melt to avoid the buildup of salt crystals. After rinsing squeegee pavers dry.

Bison 2CM Paver Installation Instructions

NOTE: For more information, please reference the most up to date version of Bison Specifications and Details, which can be found online at www.bisonip.com.

Project Conditions: Recommended minimum installation temperature is 50°F (10°C) and rising. 2CM Pavers can become brittle in extremely cold conditions. Use additional caution when handling, working with, or working on top of pavers in temperatures colder than 50°F (10°C). Bison 2CM Pavers, Paver Trays, and Pedestals are for use with pedestrian traffic only.

Installation: Bison 2CM Pavers can be installed over joist systems or Bison Pedestals from 0.50" (12.7 mm) to 36" (914.4 mm) in height. Bison 2CM Pavers MUST be used with the Bison Paver Tray (Model PT-TRAY-2424-3) when installed on Bison Pedestals. Use Bison Pedestal Tabs to ensure adequate spacing. Use of the Bison Fastening Spline (Model FS-12) is strongly recommended.



PAVER TRAY

August 2021

STRENGTH, SUPPORT, AND SAFETY

BISON PAVER TRAY

Ideal for use with Bison Pedestals, the Bison Paver Tray offers a simple and lightweight paver backing to enhance the impact resistance and provide additional strength to paver surface materials for outdoor areas.

- Weather resistant galvanized steel tray
- Can be adhered to the desired surface pavers on site before or during installation
- Exclusive Bison FS-12 Fastening Kit and continuous Paver Tray channel allow for easy paver attachment, removal, and replacement
- Standard 24" x 24" modular size fits 595-603 x 595-603 mm pavers
- Recommended for use on Bison Pedestals 1/8" to 36" in height
- Meets ASTM E136 testing requirements as a non-combustible surface material



©2016-2021 United Construction Products, Inc. All Rights Reserved.
Covered by one or more patents or pending patents.

Bison Innovative Products | 701 Osage Street, Unit 120, Denver CO 80204 USA | 800-333-4234 | www.bisonip.com



MiraTread



VersaTread



ValuTread



Custom

**THE TRUSTED CHOICE
IN PRECAST CONCRETE
STAIR TREADS SINCE 1962**

Bertelson Precast manufactures high-performance precast concrete solutions that are designed for easier installation, strength and longevity.

Our USA-made products are manufactured using time-tested proprietary processes by our team of skilled and dedicated craftsmen at our seven acre facility in Modesto, California. We are constantly innovating our manufacturing processes and products to meet our clients' needs.

We've earned a reputation as a client-centric company, dedicated to superior craftsmanship and design. Our goal is to provide you the best in precast concrete solutions: exactly what you need, when and where you need it, within your budget. You can depend on us

SELECTION. STRENGTH. STYLE.

Whether you're an architect, builder, general contractor or property manager, we have the right stair tread for your project. From our sturdy basic ValuTread, to our popular indoor/outdoor VersaTread, to our elegant interior MiraTread, our stair treads are perfect for just about any situation.

With products for both exterior and interior usage, our sturdy and durable precast concrete stair treads and landing platforms come in a variety of sizes, colors, styles and finishes to suit your project's design.

ValuTread™

Designed for multifamily and single-family residential and commercial applications, our economy-priced ValuTread line, available in both open and half riser styles, is ideal for projects that require a durable basic stair tread that stands up to high foot traffic.

VersaTread™

Our VersaTread line is recognized for its versatility and sturdiness. Easy to maintain, and available in a wide variety of sizes, colors and styles, these popular stair treads and landing platforms are designed for both exterior and interior use, and are durable in any weather condition. Available in closed riser style only.

MiraTread™

Decorative polished interior stair treads and landing platforms create a dynamic look to a staircase and can add a stylish and uniform look to any building, campus or event center. Whether you're creating a contemporary or classic design, our MiraTread line offers the perfect fusion of high-end style and functionality. Choose from an array of striking color combinations and finishes, or talk with our sample department about creating a custom mix.

© 2020, Bertelson Precast Corp.

Model: WL-LED101

LEDme® Step Light

WAC LIGHTING

Responsible Lighting®



Fixture Type:

Catalog Number:

Project: _____

Location: _____

PRODUCT DESCRIPTION

Horizontal rectangle LEDme® Step Light with Anti-microbial powder coat paint proven to restrain a wide range of bacteria, coliform, mold, fungus, algae, and yeast. Designed for safety and style on stairways, patios, decks, balcony areas, walkways and building perimeters.

Features an architectural design. Energy efficient for long-lasting indoor and outdoor lighting solutions. Creates an attractive, romantic impression at night.

FEATURES

- Direct wiring, no driver needed
- Low profile, flush to wall aesthetics with no visible hardware
- 54,000 hour rated life
- Balanced lighting, free of shadows with minimum glare
- Up to 200 fixtures can be connected in parallel
- 5 year WAC Lighting product warranty

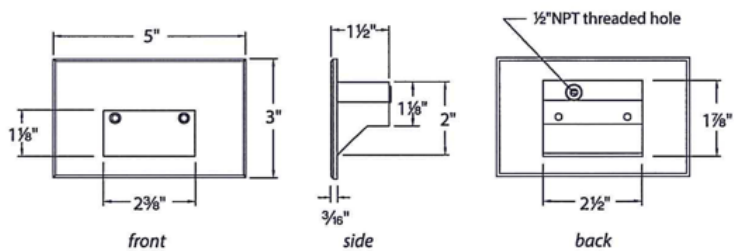

SPECIFICATIONS

Construction: Die-cast aluminum

Power: Direct wiring, no remote driver needed.

Input: 120V 50/60Hz (277V special order/3000K, Amber (AM))

Light Source: HV-AC High Power LED, CRI: 90
Optional color lenses. Total power consumption of 3.5W

Mounting: Fits into 2" x 4" J-Box with minimum inside dimensions of 3"L x 2"W x 2"H
Includes bracket for J-Box mount.

Dimming: Dim to 10% with ELV dimmer (120V only).
Approved dimmers: Lutron Nova-T NTELV-300 & NTELV-600, Lutron Vietri VTELV-600, Lutron Diva DVELV-300P, Lutron Skylark SELV-300P, Lutron Maestro MAELV-600

Standards: IP66, UL & cUL Listed for wet locations, Title 24 Compliant (120V only)

ORDER NUMBER

Model #	Light Color	Finish
WL-LED101 120V	27 2700K	WT White
	30 3000K	
	AM Amber (610nm)	

WL-LED101 - - **WT**

Example: WL-LED101-27-WT

For 277V, add "F" before CCT: WL-LED101F-30-WT

wacighting.com
Phone (800) 526.2588
Fax (800) 526.2585

Headquarters/Eastern Distribution Center
44 Harbor Park Drive
Port Washington, NY 11050

Central Distribution Center
1600 Distribution Ct
Lithia Springs, GA 30122

Western Distribution Center
1750 Archibald Avenue
Ontario, CA 91760

WAC Lighting retains the right to modify the design of our products at any time as part of the company's continuous improvement program. JAN 2019



WAREHOUSE SHADE
DAMP / WET LOCATION
CLASSIC SHAPES

PROJECT: _____
QUANTITY: _____ TYPE: _____



WS1611GV
BL - Blue Sheek



WS1611GV
AY - Aero Yellow



WS1611GV
BZ - Bronze



WS1611GV
RD - Red Baron

SERIES	LUMENS ¹	CCT	DRIVER / DIMMING ²	ACCESSORIES ⁷	MOUNTING ¹⁰	INTERIOR ¹⁴	FINISH ¹⁴	WET KIT
WS2+				DR20AFO	C104-PA23	FCI	BZ	WLKA
WS1210GV	15L 1500 Lm	80 CRI	EX ³ Electronic Driver, 120V/277V 10%, 0-10V, 120V/277V	ENCLOSURES	WALL MOUNT	MW¹⁵ Matte White	MW¹⁵ Matte White	WLKA Wet Location Kit
WS1410GV	27L 2700 Lm	27K 2700K	DS10X ⁴ 1% 0-10V, 120V/277V	TF2⁸ 4" Frosted Dome	CP104 Small Driver Canopy	CCI Custom	MB¹⁵ Matte Black	
WS1611GV	37L 3700 Lm	30K 3000K	DO10X ⁴ 1% 0-10V, 120V/277V	TG2 4" Dome Wire Guard	CP104KO Small Driver Canopy w/ Knockouts	FCI Fixture Color Interior	PT¹⁵ Platinum Silver	
WS1810GV	55L 5500 Lm	35K 3500K	DS2W1 ⁴ ELV/MLV, 120V	MF2 4" Frosted Mini	CP106 Large Driver Canopy	See Page 5 for Full Range of Color Options (83-90082)	See Page 5 for Full Range of Color Options (83-90082)	
WS2015GV		40K 4000K	DLTE1 ⁴ Lutron® 2-Wire Forward Phase (MLV), 120V	MG2 4" Short Wire Guard	CP6/RMD Remote Mount Driver			
		90 CRI	DL3EX ⁴ 1% Lutron® EcoSystem®, Fades to Black, 120V/277V	FJ2 4" Frosted Tall	SP90¹¹ Shalim™ Mounting Arm Style			
		27HK 2700K		FG2 4" Tall Wire Guard	PA¹¹ Mounting Arm Style			
		30HK 3000K		FIXTURE WIRE GUARDS⁹	LENS MOUNT			
		35HK 3500K		See 2 nd Page for Ordering Details	RDC5 Small Driver Canopy			
		40HK 4000K		DOORS & LENSES	CP13 Large Driver Canopy			
				DR (See 2 nd Page for Ordering Details)	HM¹² Hang Straight			
					AT¹² Hang Straight All Thread			
					PM¹² Rigid Pendant Mount			
					CD¹² Cord / Cable Mount			
					CD72 72" Cord / Cable Mount			
					CM¹² Cord Mount			
					EMCR¹³ 10W Large Driver Canopy EM			
					EMRM 7W Remote EM			
					EMEN 7W Remote with Enclosure			

QUICK SHIP
EXAMPLE: WS1210GV37L30KEXTF2/CP104PA23MMWIRD

NOTES:
1 Nominal Source Lumens at 35K 2 Contact Factory for Additional Options 3 37L Max with CP104 4 Available with CP106/RDC5/CP13 Only
5 37L Max with CP104/RDC5, 55L Max with CP106/CP13 6 Available with CP106/CP13 Only 7 Enclosure, Wire Guard or Door & Lens Required - Choose One Option
8 Standard Enclosure 9 Wire Guard Requires TF2 Enclosure 10 See Mounting Page for Details on Components and Finishes
11 See Mounting Page for Available Arm Options 12 Specify Length in Inches; see Mounting Page for Available Lengths 13 EMCRC Replaces RDC5 or CP13
14 See Color Page for More Options/Consult Factory for Special Finishes 15 Standard Finishes





WAREHOUSE SHADE
DAMP / WET LOCATION
CLASSIC SHAPES

LUMENS / WATTAGE DATA				
PART NUMBER	SOURCE LUMENS ¹	DELIVERED LUMENS ²	SYSTEM WATTS	LPW
WS1611GV15L	1500	1166	10	117
WS1611GV27L	2700	2038	18	113
WS1611GV37L	3700	2988	26	115
WS1611GV55L	5500	4401	39	113

¹ Nominal Source Lumens at 35K; ² Nominal Delivered Lumens at 35K

HOUSING DIMENSIONS

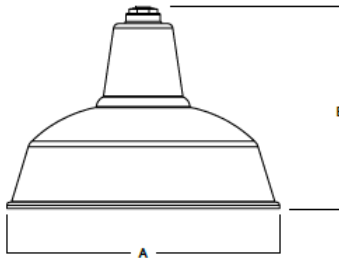

Dimensioned with WS1611GV

SERIES	A	B
WS1210GV	12.50	9.87
WS1410GV	14.50	11.68
WS1611GV	16.50	12.18
WS1812GV	18.50	12.68
WS2015GV	20.00	13.19

QUICK SHIP

Quick Ship Surface highlights products that can ship in 5 - 10 working days.

APPLICATIONS

The Warehouse Shade is one of our most popular RLM styles.

FEATURES

Spectrum Lighting's RLM Classics are inspired by vintage lighting fixtures redesigned with modern LED light sources and materials. The wide range of options for illumination, mounting, enclosures, guards and finishes allows for creative fixture specification and design. LED module and driver are serviceable for future replacement. Available in five sizes.

FINISH

Multi-stage polyester powder-coat process applied on our dedicated paint lines. Variety of standard and custom finishes are available. Interior is Matte White unless specified. Custom Color interior finishes available.

ELECTRONICS

GV LED system features high brightness white Samsung LEDs, 3-step MacAdam Ellipse binning. Standard CRI: 80+. Higher CRI, R9 and custom LED configurations are available; consult factory. Choice of electronic 120V/277V and dimming drivers.

CONSTRUCTION

Fixture shades are spun in our factory from 0.063 high purity aluminum. Wall mount canopies are die-cast aluminum with stainless steel hardware. Wall arms are formed 3/4 NPT aluminum pipe and may be field cut.

CODE COMPLIANCE

BAA compliant. ETL certified to meet US and Canadian standards. Suitable for dry or damp locations. Wet Location Option. Manufactured and tested to UL standards No. 1598/8750.

SERIES SIZES

WS1210GV



WS1410GV



WS1611GV



WS1812GV



WS2015GV



ENCLOSURES

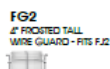
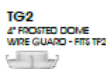

FIXTURE WIRE GUARDS

- WG12- 12" Ø
- WG14- 14" Ø
- WG16- 16" Ø
- WG18- 18" Ø



WS1611GV SHOWN WITH WG16

DOORS

- DR12A- 12" Ø
- DR14A- 14" Ø
- DR16A- 16" Ø
- DR18A- 18" Ø
- DR20A- 20" Ø

LENSES

- FO- WHITE OPTICAL ACRYLIC
- SO- SOLITE™ LENS



WS1611GV SHOWN WITH DR16AFO

WALL MOUNT

(SEE MOUNTING PAGES FOR MORE OPTIONS & DIMENSIONS.)

FA MOUNTING ARM STYLE



WS1611GV SHOWN WITH CP10LPA23

CEILING MOUNT

(SEE MOUNTING PAGES FOR MORE OPTIONS & CANOPY DIMENSIONS.)

HM / AT / PM HANG STRAIGHT / ALL THREAD / PENDANT



WS1611GV SHOWN WITH ROCSPM

CD CORD / CABLE MOUNT



WS1611GV SHOWN WITH ROCSCD

CM CORD MOUNT



WS1611GV SHOWN WITH ROCSCM



WAREHOUSE SHADE
DAMP / WET LOCATION
 CLASSIC SHAPES / PHOTOMETRIC DATA

WS1611GV-55L-35K-EX-TF2-MWI

CANDLEPOWER CURVE

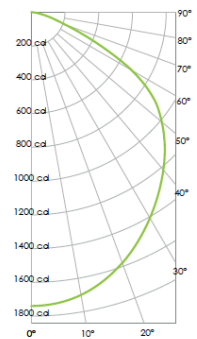

Delivered Lumens: 4,394
 Luminaire Watts: 39
 LER: 112.67

INTENSITY

0.00°	0.00°
0.00°	1,739
5.00°	1,730
10.00°	1,700
15.00°	1,648
20.00°	1,579
30.00°	1,407
40.00°	1,219
50.00°	1,010
60.00°	688
70.00°	216
80.00°	54
90.00°	0

CP at 0deg (Nadir): 1,739
 CRI: 85+

ZONAL LUMENS

0° - 10°	174	4%
0° - 20°	635	14%
0° - 30°	1,323	30%
0° - 40°	2,145	49%
0° - 60°	3,781	86%
0° - 80°	4,362	99%
0° - 90°	4,394	100%
Total	4,394	100%

SINGLE UNIT: PERFORMANCE
 INITIAL FOOTCANDLES
 BASED ON IES BEAM ANGLE

Mounting Height AFF	FC at Center on Floor	Beam Diameter	FC at Beam Edge
8.0'	27 fc	23.2'	8 fc
10.0'	17 fc	29.0'	5 fc
12.0'	12 fc	34.7'	4 fc
14.0'	9 fc	40.5'	3 fc
16.0'	7 fc	46.3'	2 fc
20.0'	4 fc	57.9'	1 fc
24.0'	3 fc	69.5'	1 fc
28.0'	2 fc	81.1'	1 fc

Beam Angle: 110.62
 Spacing Ratio: 1.2

MULTIPLE UNITS: PERFORMANCE
 80/50/20% REFLECTANCES
 INITIAL FOOTCANDLES AND WATTS PER SQUARE FOOT

Ceiling Height	Fixture Spacing	RCR 1		RCR 3	
		FC *	W/Sq. Ft.	FC *	W/Sq. Ft.
17'	16'	17	0.14	10	0.11
21'	18'	15	0.13	12	0.13
25'	20'	12	0.10	8	0.08
Delivered Illuminance Rating: (DIR)		116 FC per W/Sq. Ft.		91 FC per W/Sq. Ft.	

3' Suspension Length
 Square rooms used for multiple units:
 - RCR 1: Length & Width = Ceiling Ht. - 5.5' x 10.00
 - RCR 3: Length & Width = Ceiling Ht. - 5.5' x 3.33
 * Average Footcandles at 2.5' Above Floor
 ** Exceeds spacing criteria by 16%
 *** Exceeds spacing criteria by -15%

Lamp Multiplier: 15L x 0.265, 27L x 0.463, 37L x 0.679
 CCT Multiplier: 27K x 0.971, 30K x 0.985, 40K x 1.03

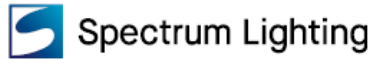

MOUNTING & ACCESSORIES

SOME OPTIONS NOT AVAILABLE ON ALL FIXTURES. CONSULT SPECIFICATION SHEETS. SEE INDIVIDUAL SPECIFICATION SHEETS OR CONSULT FACTORY FOR ADDITIONAL INFORMATION. NOTE: THIS IS TYPICAL OF RLM SPECIFICATION FOR MOUNTING. INDIVIDUAL FIXTURES OR PROJECTS MAY HAVE SPECIALIZED REQUIREMENTS.



WALL MOUNTING

CP104 - SMALL DRIVER CANOPY (STANDARD)
MAY BE USED AS SPLICE BOX FOR DIRECT FEED
NOT AVAILABLE W/ PA16 & PA16F

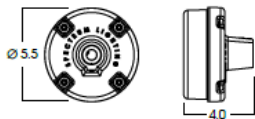

CP106 - LARGE DRIVER CANOPY
MAY BE USED AS SPLICE BOX FOR DIRECT FEED

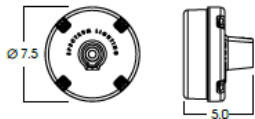

CP6/RMD - REMOTE MOUNT DRIVER
MOUNTS DIRECTLY TO WALL OR OCTAGON STYLE J-BOX



CUSTOM AND OTHER WALL ARMS AVAILABLE - CONTACT FACTORY. ARMS MAY BE FIELD CUT ON WALL SIDE - FIXTURE SIDE THREADED 3/4" NPT REQUIRES SEALANT FOR WET LOCATION.

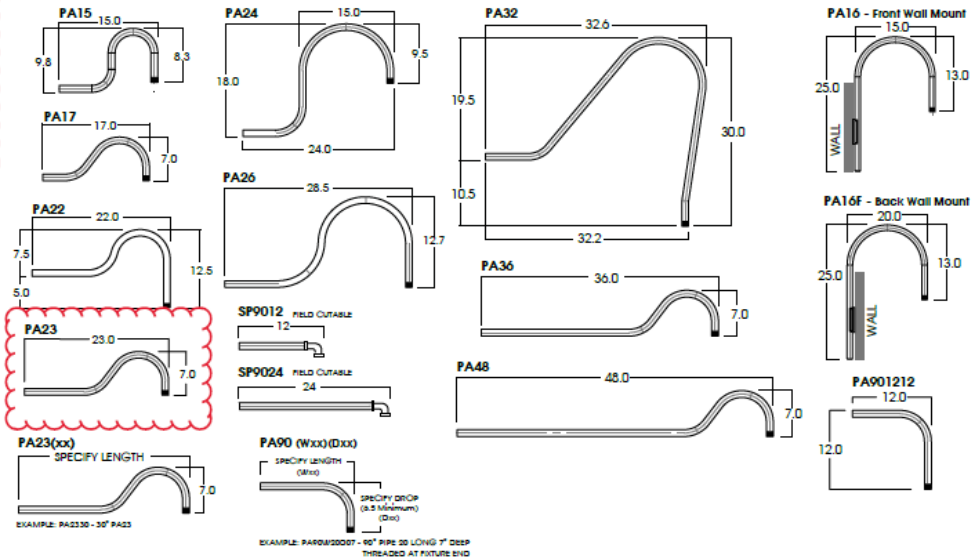

CEILING MOUNTING

RDC5 - SMALL DRIVER CANOPY (STANDARD)
MOUNTS TO 4" OCTO J-BOX

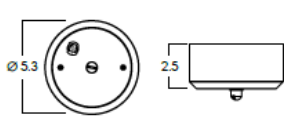

CP13 - LARGE DRIVER CANOPY



HM*
HANG STRAIGHT
45° SW/VEL 5/8" O.D. STEM - 3/8" IP

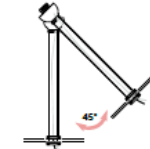

ORDER: HM (Length)
SPECIFY LENGTH:
HM3 - 3" HM24 - 24"
HM6 - 6" HM36 - 36"
HM12 - 12" HM48 - 48"
HM18 - 18" HM72 - 72"
HMLC(xxx)
Custom Length
(Specify in Inches)

PM*
RIGID PENDANT MOUNT
RIGID 5/8" O.D. STEM - 3/8" IP

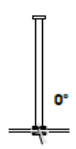

ORDER: PM (Length)
SPECIFY LENGTH:
PM3 - 3" PM24 - 24"
PM6 - 6" PM36 - 36"
PM12 - 12" PM48 - 48"
PM18 - 18" PM72 - 72"
PMLC(xxx)
Custom Length
(Specify in Inches)

AT**
HANG STRAIGHT ALL-THREAD
45° SW/VEL 5/8" O.D. STEM - 1/4" IP

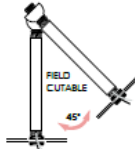

ORDER: AT (Length)
SPECIFY LENGTH:
AT12 - 12"
AT24 - 24"
AT36 - 36"
AT48 - 48"
AT60 - 60"
AT72 - 72"
FIELD CUTTABLE ***
***UP TO 1/2" MAXIMUM CUT
FROM THE END OF THE
STEM. FIELD CUTTABLE
TOP 1/4" COUPLER OVERHANGS 1/4" FROM

CD
CORD / CABLE MOUNT
5/8" CORD WITH 1/16" SS CABLE

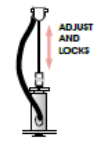

ORDER: CD (Length)
SPECIFY LENGTH:
CD36 - 36"
CD72 - 72"
CD144 - 144"
CDLC(xxx)
Custom Length
(Specify in Inches)

CM
CORD MOUNT
5/8" CORD WITH STRAIN RELIEF



ORDER: CM (Length)
SPECIFY LENGTH:
CM36 - 36"
CM72 - 72"
CM144 - 144"
CMLC(xxx)
Custom Length
(Specify in Inches)

*MAXIMUM ONE PIECE STEM LENGTH IS 72". **MAXIMUM ONE PIECE STEM LENGTH IS 36". LONGER LENGTHS ARE POSSIBLE USING MULTIPLE STEMS AND COUPLERS. ***ORDER IN 12" INCREMENTS. ODD SIZES MAY BE FIELD CUT

EMERGENCY BATTERY OPTIONS

EMCR - LARGE DRIVER CANOPY FOR 10W EMERGENCY BATTERY

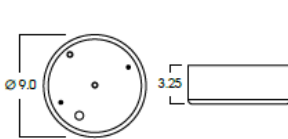

REMOTE EMERGENCY BATTERY OPTIONS

EMRM* - 7W REMOTE EMERGENCY BATTERY (50 MAX)

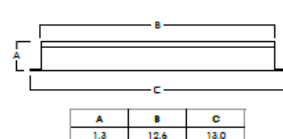

EMEN* - 7W REMOTE EMERGENCY BATTERY WITH ENCLOSURE (50 MAX)

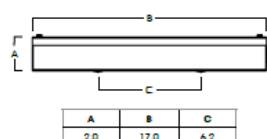

*OTHER EM BATTERY SIZES AVAILABLE. CONTACT FACTORY.



COLOR OPTIONS - POWDER COAT PAINT FINISHES

NOTE: NO PRINTED IMAGE CAN EQUAL THE EXACT COLOR OF FINISH ON METAL. SEE INDIVIDUAL SPECIFICATION SHEETS OR CONSULT FACTORY FOR ADDITIONAL INFORMATION.



STANDARD CORD / STEM / CANOPY FINISHES

FIXTURE COLOR	STANDARD CORD COLOR	STANDARD CANOPY / STEM COLOR
Matte White, Textured White	Matte White	Matte White
Gloss White	Matte White	Gloss White
Matte Black, Gloss Black, Textured Black	Matte Black	Matte Black
All Others	Matte Black	Same Color as Fixture
Custom Color	Contact Factory	Contact Factory

PAINT TIMES

TIER	COST	AVERAGE PAINT TIME*
Tier 1 - Standard Finishes	\$	⓪
Tier 2 - Typical Finishes	\$\$	⓪⓪
Tier 3 - Special Metal Finishes	\$\$\$	⓪⓪⓪
Custom Color	Contact Factory	Contact Factory

* CONTACT FACTORY FOR SPECIFIC PRODUCT LEAD TIMES

TIER 1 - STANDARD FINISHES



TIER 2 - TYPICAL FINISHES

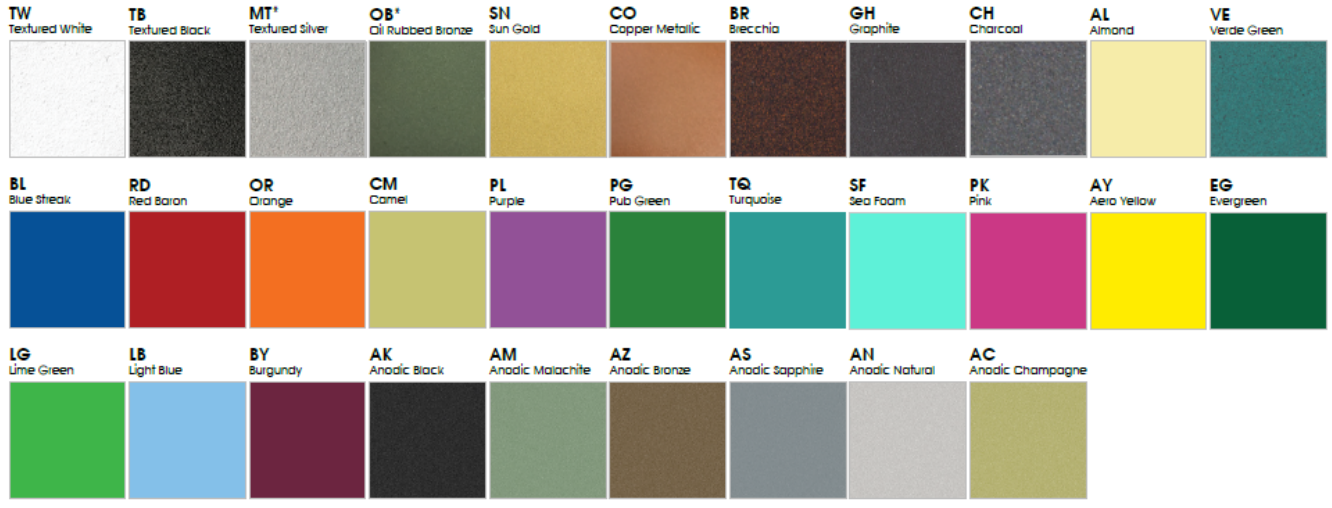

TIER 3 - SPECIAL METAL FINISHES

NOT AVAILABLE ON ALL FIXTURES. PLEASE CONSULT SPECIFICATION SHEETS OR FACTORY FOR AVAILABILITY.

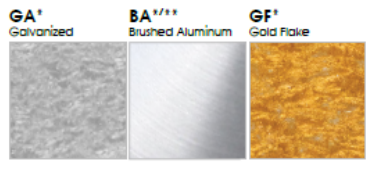

CUSTOM COLOR FINISHES

CONTACT FACTORY



* UNAVAILABLE FOR WET LOCATION
 ** UNAVAILABLE FOR INTERIOR





NATURAL STONE



Cooper Maria

Cooper Maria is a beautiful thin veneer stone. This stone is cream with beige and copper earth tones. Its calm colors accent a wide variety of color and stone types. Cooper Maria is packaged on pallets and sold by the ton.





LAPIS
1 x 1 Offset

Size: 1 x 1"

COLOR



Color: Fathom

FINISHES



WISHLIST

- COLLECTIONS
- INSPIRATION GALLERY
- ABOUT
- NEWS
- RESOURCES
- CONTACT & FAQ
- FIND A DEALER

textures add a feeling of light and air, perfect for use in Custom Blend)

Share



DOCUMENTATION

- Series Brochures ↓
- Applications & Testing ↓
- Care & Maintenance ↓

SPECIFICATIONS

Coverage	Sheet = 1.07 SF
Tile Size(mm)	25 x 25
Tile Thickness(mm)	6

Mounting	Paper Faced
----------	-------------

- RECOMMENDED USAGE & FLOOR APPLICATION

Applications	Suitable
Interior Wall/Backsplash	Yes
Fireplace/Cooktop Surround	Yes*
Shower Wall	Yes
Steam Shower	Yes
Exterior Wall	Yes
Pool, Spa or Water Feature	Yes

FLOOR APPLICATION

	Interior	Exterior
Shower	Yes	No
Steam Shower	Yes	No
Light Residential	Yes	No
Residential	No	No

* Acceptable for use near open flame or heat source; However, it is NOT considered 'Fire Glass'.

NOTES ON MATERIAL

Variation in color, shade, size, minor edge irregularities (including occasional chipped sides/edges), and surface texture (such as fissures, folds, and bubbles) are common, natural characteristics of our handmade glass tiles and should be expected.

These characteristics are the direct result of the artisan's interaction and craft with the glass medium, producing one-of-a-kind tiles intended to enhance the beauty and tone of the space.

Samples and photos are representative but may not indicate all variations of our handcrafted glass tiles.

Please review the Recommended Usage & Floor Applications charts before purchase, and see our Glass Installation Guidelines for further information.

SERIES OVERVIEW

Add the feeling of lightness and buoyancy to any design with Lapis, a collection of semi-opaque glass mosaics from Lunada Bay Tile. The glistening colors in this collection of airy, delicately textured glass tiles elevate the space and rouse the imagination. Perfect for both residential and commercial spaces.

FIND A DEALER

SEARCH

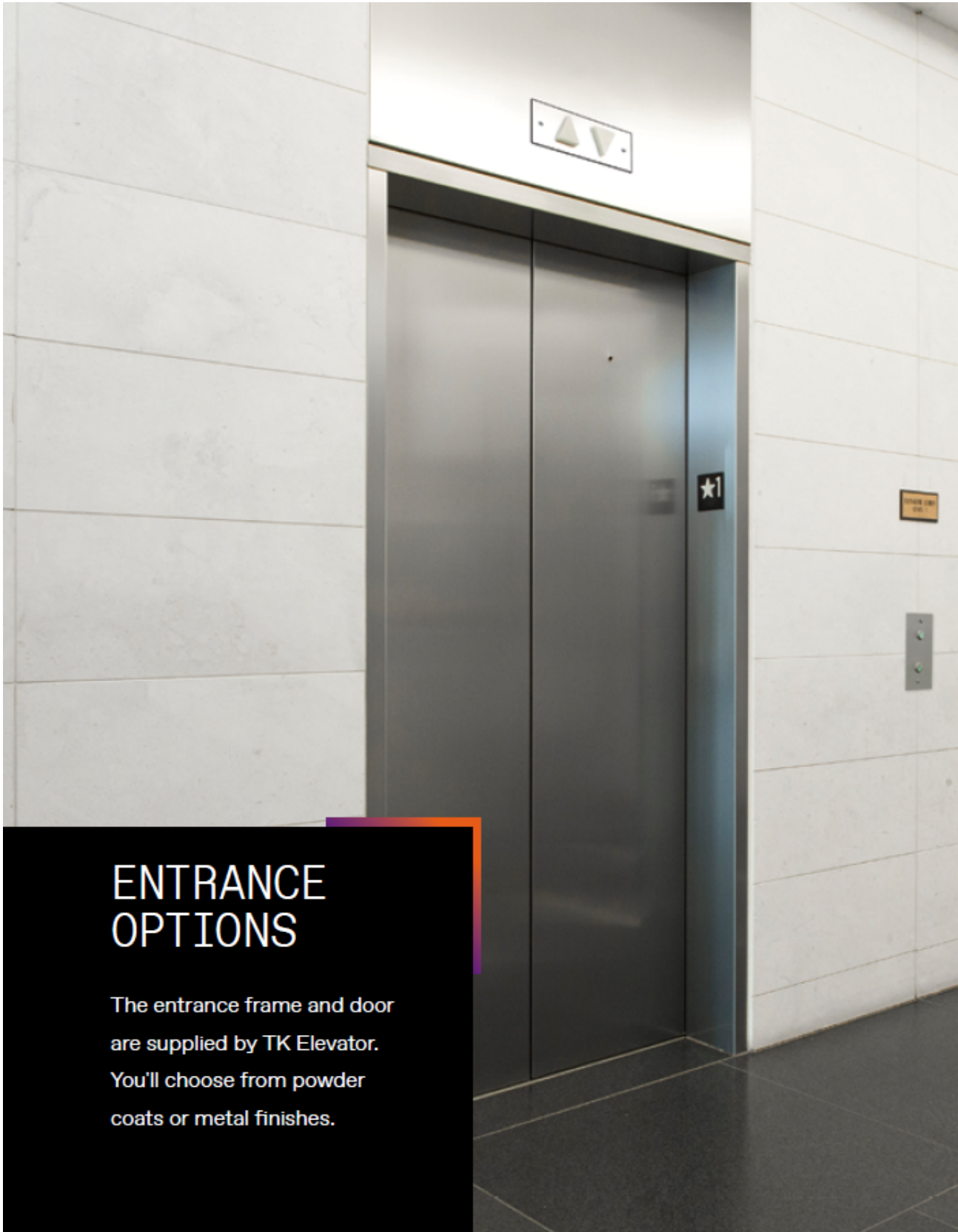

ENTRANCE OPTIONS

The entrance frame and door are supplied by TK Elevator. You'll choose from powder coats or metal finishes.

Entrance finishes

Hoistway and door entrance finishes

Typically, the entrance frame would match the door selection, but nothing says you have to. Choose from a limited selection of powder coat color or brushed stainless steel finish.



Powder coat finish
T-style entrance frame in Chalk Board powder coat.



Metal finish
T-style entrance frame in Brushed Stainless Steel.

Powder coats

Metals

--	--	--

Contact your local representative for detailed availability on our metal options.

Hoistway entrance frame

Face of frame is a standard two inches.

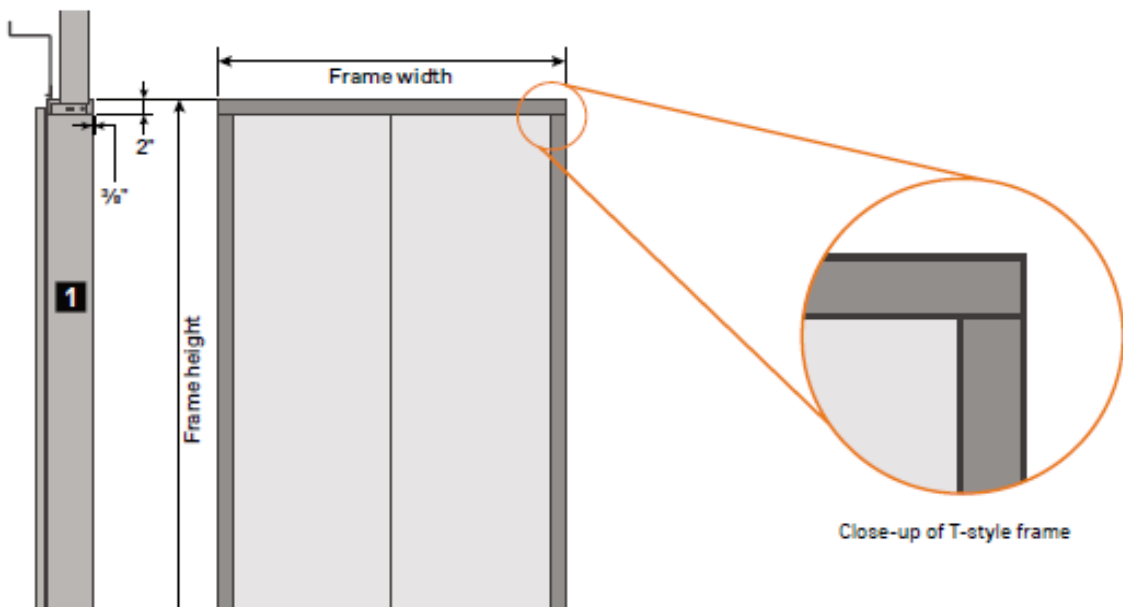

PLANNING

Above-ground jack applications



The numbers at a glance



Type
Above-ground jack



Travel
Up to 33'-6½"



Capacity
2100 – 5000 lbs



Speed
80 – 150 fpm

Holeless above-ground technical specifications

Speeds (fpm)	80, 100, 110, 125, 150 feet per minute (dependent on project-specific conditions, such as capacity, machine room location, etc.)
Maximum travel	33'-6½" with standard overhead and pit depth; serves up to six floors with additional pit and overhead
Jack types	Single, Two-stage, Three-stage (telescoping)
Power characteristics	200-480 VAC, 3 phase, 60 hertz; (single-phase application is available as an option)
Controller	TAC32
Door operator	Universal Door Operator
Manual lowering	Standard
Battery-lowering operation	Standard on machine room-less application. Available as an option on machine room application.

endura
Passenger elevators - twinpost above-ground

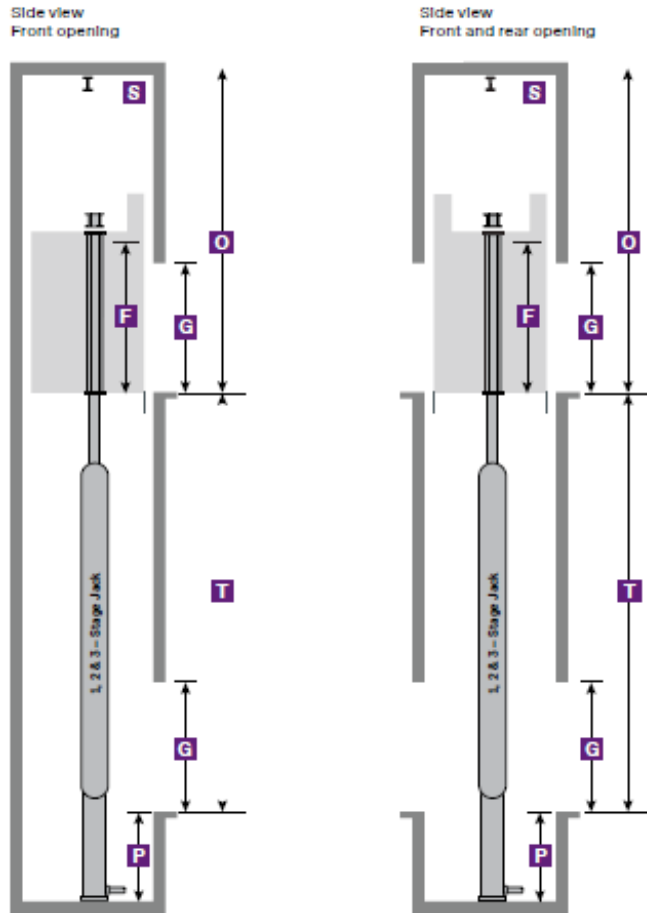

- A** Holstway width
- B** Holstway depth
- C** Inside clear width
- D** Inside clear depth
- E** Door clear width
- F** Inside clear height
- G** Door clear height
- O** Minimum overhead
- P** Minimum pit depth
- S** Safety beam
- T** Travel

One-speed center opening doors

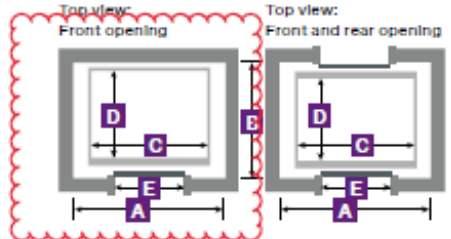

One-speed side opening doors

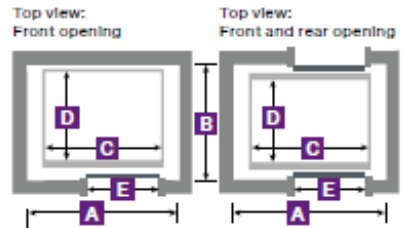

- F** Inside clear height: 7'-4"⁶
- G** Door clear height: 7'-0"
- O** Minimum overhead:
 - Up to 100 fpm: 1-Stage - 12'-2" Over 100 fpm: 1-Stage - 12'-5"
 - 2-Stage - 12'-8" 2-Stage - 12'-8"
 - 3-Stage - 12'-11" 3-Stage - 12'-11"
- P** Minimum pit depth: 4'-0"⁶
- T** Max travel possible: ¹
 - 1-Stage: Up to 100 fpm - 18'-11"
 - Over 100 fpm - 18'-8"
 - 2-Stage: 28'-6"
 - 3-Stage: 48'-3½"
- S** Safety beam required per OSHA 1926.502⁷

Passenger elevator						
Capacity (lbs)	1-and 2-Stage Holstway ^{2,8} A x B	3-stage Holstway ⁹ A x B	Front / rear	Inside clear C x D	Door type	Door width E
2100 ³	7'-4" x 5'-9"	7'-8" x 5'-9"	F	5'-8" x 4'-3"	One-speed	3'-0"
2100 ³	7'-4" x 6'-8½"	7'-8" x 6'-8½"	F/R	5'-8" x 4'-3½"	One-speed	3'-0"
2500	8'-4" x 5'-9"	8'-8" x 5'-9"	F	6'-8" x 4'-3"	One-speed	3'-6"
2500 ⁴	8'-4" x 6'-8½"	8'-8" x 6'-8½"	F/R	6'-8" x 4'-3½"	One-speed	3'-6"
3000 ⁴	8'-4" x 6'-3"	8'-8" x 6'-3"	F	6'-8" x 4'-9"	One-speed	3'-6"
3000 ⁴	8'-4" x 7'-2½"	8'-8" x 7'-2½"	F/R	6'-8" x 4'-9½"	One-speed	3'-6"
3500 ⁴	8'-4" x 6'-11"	8'-8" x 6'-11"	F	6'-8" x 5'-5"	One-speed	3'-6"
3500 ⁴	8'-4" x 7'-10½"	8'-8" x 7'-10½"	F/R	6'-8" x 5'-5½"	One-speed	3'-6"
4000 ⁴	9'-4" x 6'-11"	9'-8" x 6'-11"	F	7'-8" x 5'-5"	One-speed	3'-6"/4'-0"
4000 ⁴	9'-4" x 7'-10½"	9'-8" x 7'-10½"	F/R	7'-8" x 5'-5½"	One-speed	3'-6"/4'-0"

Contact your local representative for various code or jurisdictional exceptions, or alterations required.

See endnotes on page 29.

Rockport Gray

HC-105



A rich medium gray with the barest trace of violet undertone.

[Add to Cart](#)



[Find a Store](#)

[Benjamin Moore](#) [Paint Colors](#) [Products](#) [Paint Ideas](#) [For Professionals](#)